

**OFF-
ROAD
LIVIN'**



can-am®

**2021 ACCESSORIES
APAC EDITION**

MAVERICK SPORT

**YOU WANT IT?
WE'VE GOT IT.
SO GET
EXPLORING.**

**FIT &
COMPATIBILITY**



FOR US, INNOVATION IS A NO BRAINER.
ALL OUR ACCESSORIES WORK TOGETHER,
RIGHT OUT OF THE BOX. SO TAKE YOUR
PICK. THEN PICK SOME MORE.

can-am[®]



STYLE & VISION



WE'VE UPPED THE ANTE ON ACCESSORIES. NOT JUST DESIGNED TO LOOK GOOD, BUT PERFORM RIGHT FOR REAL RIDERS. ALL KILLER, NO FILLER.

QUALITY & RELIABILITY



OUR CAN-AM ACCESSORIES ARE MADE RIGHT THE FIRST TIME. AND TO TOP IT OFF WE THREW IN A 1-YEAR WARRANTY. YOU'RE WELCOME. INSTALL THEM YOURSELF OR AT AN AUTHORIZED DEALER.

**BRP 1-YEAR
LIMITED WARRANTY**

For new Can-Am accessories, genuine parts, and co-branded products sold through BRP. Includes items installed by you or an authorized BRP dealer.

2021



**EXPERT
CHOICE**

LOOK FOR THIS LOGO THROUGHOUT THE CATALOGUE FOR EXPERT RECOMMENDATIONS ON INNOVATIVE, MUST-HAVE, ENTHUSIAST-READY PARTS AND ACCESSORIES THAT WILL HELP YOU CUSTOMIZE YOUR PERFECT OFF-ROAD MACHINE.



can-am

**MAVERICK TRAIL
MAVERICK SPORT**

ACCESSORIES

Built Inspirations	6
Build Your Own	11
Roofs	12
Soft Cab Enclosure	16
Windshields & Mirrors	17
Doors	21
Rear Wind Protection	24
Skid Plates	25
Bumpers & Guards	26
Seat Accessories	35
LinQ: Easy on, easy off Cargo	36
Cargo & Storage	41
Racks & Holders	43
Lights	47
Audio & Communication Systems	52
Electrical & Electronic	54
Winches & Hitches	58
Performance	60
Apache™ Track Systems	63
ProMount Plows	66
Trailerling	72
Tires & Rims	73

CAN-AMOFFROAD.COM

**OFF-
ROAD
LIVEN'**

© 2020 Bombardier Recreational Products Inc. (BRP). All rights reserved. ®, TM and the BRP logo are trademarks of BRP or its affiliates. CARLISLE is a trademark of Carlisle Companies. CHAMUDE and HIPORA are registered trademarks of Kolon Industries, Inc. CLARINO is a trademark of Kuraray Co. Ltd. COOLMAX and THERMOLITE are registered trademarks of INVISTA for durable fabrics. DRIRELEASE is a registered trademark of Optimer Inc. FOX is a registered trademark of Fox Racing Canada. GARMIN and MONTANA are registered trademarks of Garmin Ltd. iPod is a registered trademark of Apple Inc. KOLPIN, GUN BOOT and IMPACT are registered trademarks of Kolpin Powersports Inc. KYB is a registered trademark of Kayaba. MicroSD is a registered trademark of SD Card Association. Mud Lite XTR and SS312 are trademarks of ITP Tires. NEXT G-1 VISTA is a trademark of Next Camo, LLC. NGK is a registered trademark of NGK Spark Plugs, Ltd. PRIMALOFT GOLD and PRIMALOFT BLACK are registered trademarks of Albany International Corp. TEFLON, TEFLON HT and KEVLAR are trademarks of E.I. DuPont de Nemours & Co. TWINAIR is a trademark of Twin Air USA. UNI is a trademark of UNIFILTER Inc. VELCRO is a registered trademark of Velcro Industries. WARN is a trademark of Warn Industries Inc. YUASA is a registered trademark of YUASA Batteries Inc. ZILLA and BIGHORN 2.0 are trademarks of Maxxis. SCOTT is a trademark of Scott Sports SA. The following trademarks are the property of their respective owners: BLUETOOTH, CREE, DURO, DWT, HELLA, ITP, KENDA, MOSSY OAK, RAM, SUR LAST, VISION, XPS and YOSHIMURA. DRAGONFIRE is a trademark of KRANSCO. Baja Designs is a registered trademark of Baja Designs Inc. S3 POWERSPORTS is a trademark of S3 Power Sports LLC. Some models depicted herein may include optional equipment. Prices, if shown, are based on Manufacturer Suggested Retail Prices. Dealers may sell for a different price. For Canada and US, taxes are not included. Depending on location, products are distributed by BRP US Inc., Bombardier Recreational Products Inc., BRP European Distribution SA, BRP Finland Oy, BRP Australia Pty Ltd. or BRP Brasil Motorsports LTDA. BRP reserves the right, at any time, to discontinue or change specifications, prices, designs, features, equipment without incurring obligation.

EXPERTLY-CHOSEN PACKAGES

ADD THE ACCESSORIES YOU WANT WITH 3 LEVELS OF UPGRADES: **STARTER**, **ADVANCE**, AND **PEAK**. OR MIX AND MATCH OPTIONS—IT'S YOUR RIDE.

STARTER

Essential, recommended upgrades to immediately enhance any Can-Am vehicle.

ADVANCE

The best all-round, do-anything upgrades that have proven popular with experienced riders and new owners alike. Transform your Can-Am for the years of riding ahead.

PEAK

Limits are for other people: build your Can-Am Off-Road vehicle to overcome bigger obstacles & ride through larger adventures.



PERFORMANCE



ACTION



WINTER



ADVENTURE

YOU CAN FINANCE THE PURCHASE OF ACCESSORIES
with the purchase and financing of your Defender. Ask your dealer for all the details.



READY TO BUILD
YOUR MAVERICK
SPORT BEYOND
FACTORY FRESH?

MAVERICK SPORT

PERFORMANCE

STARTER

715003831	Lonestar Racing Aluminum Roof	p. 15
715004871	Lonestar Racing Front Bumper	p. 31
715004873	Lonestar Racing Rear Bumper	p. 31
295100698	LinQ 4.2 Gal (16 L) Cooler	p. 38

ADVANCE

715004875	Lonestar Racing Rock Sliders	p. 32
715004872	Lonestar Racing Front Intrusion bar	p. 32
715005414	Lonestar Racing Rear Intrusion Bar	p. 32
710006028	Wet Sounds Stealth 6 Ultra HD Sound Bar	p. 52
715004007	39" (99 cm) Double Stacked LED Light Bar	p. 48
715004877	Lonestar Racing Mounts for LED Light Bar	p. 51

PEAK

715004876	Lonestar Racing Spare Tire Holder	p. 32
715004878	Lonestar Racing Number Plate	p. 32
715008035	4-Point Harness – Driver	p. 35
715008036	4-Point Harness – Passenger	p. 35
715004452	Yoshimura Slip-On Exhaust	p. 61

*Note that price does not include installation requirements and that part numbers may vary depending on vehicle model.

TRAIL-TUNED
ACCESSORIES
THAT SHARPEN
YOUR RIDE
TO PERFECTION.



MAVERICK SPORT X xc

ACTION

STARTER

715006218	Sport Roof	p. 13
715005210	ProVent Windshield	p. 20
715005887	Soft Rear Window	p. 24
715003639	Side Mirrors	p. 20

ADVANCE

715003680	Front Trail Bumper	p. 27
715007109	Rear Trail Bumper	p. 27
715003701	All-Terrain Trunk Cover	p. 41
715006416	Can-Am HD 4500 Winch	p. 58
710006820	Baja Design Squadron Sport LED Lights	p. 47
715004914	Door Storage with Padding	p. 23
715004471	Spare Tire Carrier	p. 45

PEAK

715003672	Complete Wet Sounds Audio	p. 52
715003716	Yoshimura Exhaust	p. 61
715005212	Device Holder	p. 53

*Note that price does not include installation requirements and that part numbers may vary depending on vehicle model.



THRIVE IN THE DEEPEST SNOW—FOR WORK OR PLAY. YOUR CAN-AM WAS BORN TO BE A WINTER WARRIOR.

MAVERICK TRAIL

WINTER

STARTER

715003618	Soft Cab Enclosure	p. 16
715003678	Defrost, Heat & Ventilation System	p. 55
715004290	Engine & CVT Pre-Filter kit	p. 62

ADVANCE

715003638	Panoramic Center Mirror	p. 20
715003771	LinQ Rack Extension	p. 45
710006028	Wet Sounds Stealth 6 Ultra HD Sound Bar	p. 52
715004500	Heated Grab Bar Cover	p. 55
715004283	Heated Steering Wheel	p. 55
715004501	Heated Seat Cover	p. 55
715003665	3.5" (9 cm) LED Flood Lights	p. 49
715003666	3.5" (9 cm) LED Driving Lights	p. 49

TRACKS

715005103	Apache 360LT Track System	p. 65
715004833	Apache 360 LT Track Mount Kit	p. 65

PLOW

715006417	Can-Am HD 4500-S Winch	p. 58
715005201	Can-Am ProMount Steel 60" (152 cm) Plow Kit	p. 67
715004205	Can-Am ProMount Blade Extension	p. 70
715004206	Can-Am ProMount Edge Markers	p. 70
715006258	Can-Am ProMount Drift Cutters	p. 70

*Note that price does not include installation requirements and that part numbers may vary depending on vehicle model.



SHOW YOUR FRIENDS
REAL ADVENTURE WITH
ADRENALINE-INDUCING
ADD-ONS FOR THE
MAVERICK SPORT.

MAVERICK SPORT MAX

ADVENTURE

STARTER

715004704	Sport Roof	p. 13
715003658	PowerFlip Windshield	p. 18
715006113	Rear Polycarbonate Window	p. 24
715003680	Front Trail Bumper	p. 27
715007109	Rear Trail Bumper	p. 27
715004301	LinQ Tool Box	p. 38
295100698	LinQ 4.2 Gal (16 L) Cooler	p. 38
715004708	LinQ Pivoting Rack	p. 44

ADVANCE

715003639	Side Mirrors	p. 20
715004007	39" (99 cm) Double Stacked LED Light Bar	p. 48
715003668	Roof Tail Light	p. 51
715003672	Complete Wet Sounds Audio System	p. 52
715004095	Adventure Roof Rack	p. 43

PEAK

715006351	HMWPE Skid Plate Protection kit	p. 25
715004923	LinQ 23 Gal (86 L) Trunk Box	p. 40
715004794	Removable Center Storage Bag	p. 42
715004452	Yoshimura Performance Slip-on Exhaust	p. 61

*Note that price does not include installation requirements and that part numbers may vary depending on vehicle model.

YOU'VE SEEN THE OPTIONS... NOW
BUILD YOUR OWN



Create the ride you always dreamed of using
our outstanding range of quality accessories.

Customize your own Can-Am Off-Road at
[CAN-AM.BRP.COM/OFF-ROAD](https://can-am.brp.com/off-road)

ROOFS

MADE WITH HIGH-QUALITY MATERIALS DESIGNED IN CONCERT WITH YOUR CAN-AM, OUR ROOFS CREATE A STRONG, LIGHT, RESILIENT BARRIER FROM THE ELEMENTS.

100%
integrated

into the design
of all Can-Am
cab components.



⇒ MAKE IT YOURS

Roof options are the perfect platform for numerous Can-Am accessories that truly transform your Maverick Trail or Maverick Sport.

⚙️ BUILT FOR YOUR VEHICLE

Engineered with the same design, fit, finish, and built-to-last quality found across our lineup

EXPERT CHOICE

SPORT ROOF

- Excellent protection from the elements.
- Allows to install lights at roof top location.
- Compatible with all windshields.

Maverick Trail, Maverick Sport

- Robust injection-molded polypropylene construction.
- 715006218**

Maverick Sport MAX

- Robust thermoformed HMWPE construction.
- 715004704**



EXPERT CHOICE

PROVENT ROOF MODULE KIT

- Provides fresh air into the cab area.
- Optimal performance with full cab enclosure.
- 4 vents provide infinite adjustment of air flow for driver and passenger.
- Filter and pre-filter to limit dust intrusion.
- Easy cleaning of filter and pre-filter.
- Patent pending water management system to keep water out of cabin while maintaining air flow.
- Outer plug closes air intake completely for winter or heavy weather.
- Not compatible with roof mounted LED bars, roof racks or roof liners.
- Requires ProVent Roof Module Adapter kit (715005213), no requirement for Can-Am Aluminium Roof.

Maverick Trail, Maverick Sport

715005279



PROVENT ROOF MODULE ADAPTER KIT FOR SPORT ROOF

(Not illustrated)

- Adapter for fitting ProVent Roof Module kit onto Maverick Sport or Maverick Trail Sport Roof.
- Includes roof adapter and hardware.
- Requires ProVent Roof Module kit (715005279).

Maverick Sport, Maverick Trail

715005213 • Black



LONESTAR RACING ALUMINUM ROOF

- Race-true low profile look with integrated front visor for eye-popping performance and protection.
- 0.083" (2.1 mm) thick aluminum roof for durable and lightweight protection from the elements.
- Compatible with Lonestar Racing Mounts for 39" (99 cm) Double Stacked LED Light Bar (715004877).
- Not compatible with Full Windshields, Rigid Rear Window, Can-Am and Dragonfire Intrusion Bars and Overhead Switch Panel.

BIMINI ROOF WITH SUN VISOR

- Heavy-duty canvas made of UV-resistant solution-dyed polyester.
- Soft top comes with a hard visor that allows for storage of rolled-up soft top and mounting auxiliary lights.
- Not compatible with the Glass Windshield with Wiper.

Maverick Trail, Maverick Sport
715003661

Maverick Sport MAX
715004792





Maverick Trail, Maverick Sport

■ 715005137 • Black

■ 715003831 • Can-Am Red

Maverick Sport MAX

■ 715004892 • Can-Am Red



DRAGONFIRE ALUMINUM ROOF

- Durable and lightweight formed aluminum roof with durable powder coat finish.
- Sleek lines designed to match your vehicle's body and greatly enhance the overall look.
- Not compatible with Glass windshield.

Maverick Trail, Maverick Sport

715004458

Maverick Sport MAX

715004891



SOFT CAB ENCLOSURE



Easily remove upper soft door panels when the weather improves!

WRAP YOURSELF IN COMFORT.

Outstanding Soft Cab Enclosure gives protection and comfort against all the elements.

Maverick Trail

- Includes:
- Sport Roof
 - Full Windshield – Hardcoated
 - Upper Soft Door Panels
 - Soft Rear Panel
 - Door Seal kit
 - Requires Half Doors on 800 Base and 800 DPS models
 - Not compatible with Sport Half Doors
- 715003618**



MAVERICK TRAIL

Maverick Trail / Maverick Sport

- Can be installed on the Maverick Trail equipped with the Sport Half Doors or on Maverick Sport models.
- Includes:
- Sport Roof
 - Full Windshield – Hardcoated
 - Upper Soft Door Panels
 - Soft Rear Panel
- 715004724**



MAVERICK SPORT MAX

Maverick Sport MAX

- Includes:
- Sport Roof
 - Full Windshield – Hardcoated
 - Upper Soft Door Panels
 - Soft Rear Panel
- 715004725**

DESIGN YOUR OWN CAB.

PICK THE ACCESSORIES OF YOUR CHOICE AND BUILD OR COMPLETE YOUR OWN CAB.



100% modular components designed to work together:

ROOFS P.12
WINDSHIELDS P.17

DOORS P.21
REAR WINDOWS P.24

WINDSHIELDS

DEVELOPED TOGETHER WITH YOUR MAVERICK SPORT AND MAVERICK TRAIL TO ENSURE THEY FIT, LOOK AND PERFORM AS THEY SHOULD.



QUANTUM' COATING

Our Full Windshield – Hardcoated is made of high-impact-resistant Quantum' hardcoated polycarbonate to ensure durability.



OVER CENTER LATCHES

Quick and easy tool-less installation or removal as the conditions and your needs change.



POWERFLIP WINDSHIELD

Allows you to quickly adapt to changing conditions by adjusting the windshield as you go.



100% INTEGRATED

Your Can-Am's standard profiled cage allows our accessories to install easily, with a perfect fit.



**EXPERT
CHOICE**

POWERFLIP WINDSHIELD

- The PowerFlip Windshield is equipped with electric cylinders that allow the rider to adjust the windshield opening at the touch of a button.
- Windshield is made of hardcoated polycarbonate with a rubber seal contour and a tinted top section.
- Allows you to quickly adapt to changing conditions by adjusting the windshield as you go.
- Can be fully opened for optimal visibility and ventilation, fully closed for maximum protection from the elements, and in between, you have an infinite number of opening possibilities depending on protection, visibility and air flow preferences.
- Compatible with Can-Am roofs.

Maverick Trail, Maverick Sport,
Maverick Sport MAX
715003658



TOTAL AIR FLOW CONTROL

INDUSTRY'S FIRST POWERED FLIP WINDSHIELD



FULLY CLOSED

for maximum protection from the elements



**INFINITE POSSIBILITIES
IN BETWEEN**

depending on protection, visibility and air flow preferences



FULLY OPENED

for optimal visibility and ventilation



GLASS WINDSHIELD

- Curved and laminated glass full windshield in metal frame.
- Provides excellent optical clarity.
- Seals firmly against the cage and protects rider and passenger from the elements.
- Must be used with Windshield Wiper and Washer kit (715003654) to maintain clear visibility during severe riding conditions, such as mud riding.
- Must be used with rear wind protection.
- Not EC compliant.

Maverick Trail, Maverick Sport, Maverick Sport MAX
715003653



GLASS WINDSHIELD WITH WIPER

- (Not illustrated)
- Curved and laminated glass full windshield in metal frame.
 - Provides excellent optical clarity.
 - Seals firmly against the cage and protects rider and passenger from the elements.
 - Single-speed wiper with washer fluid dispenser.
 - Requires the Overhead Switch Panel (715003669) for installation.
 - Must be used with rear wind protection.
 - Not EC compliant.

Maverick Trail, Maverick Sport, Maverick Sport MAX
715003652

WINDSHIELD WIPER AND WASHER KIT

- An ideal way to keep your windshield clear in rain, or while riding through mud and water.
- Includes single-speed wiper, washer fluid dispenser and windshield frame mount.
- Must be used with the Glass Windshield (715003653).
- Requires the Overhead Switch Panel (715003669) for installation.
- Not EC compliant.

Maverick Trail, Maverick Sport, Maverick Sport MAX
715003654



EXPERT CHOICE

FULL WINDSHIELD - HARDCOATED

- High-impact-resistant Quantum¹ hardcoated polycarbonate full windshield.
- Formed polycarbonate construction for enhanced rigidity.
- Provides excellent optical clarity and better abrasion resistance.
- Seals firmly against the cage and protects rider and passenger from the elements.
- Must be used with rear wind protection.
- Quick and easy tool-less installation or removal.

Maverick Trail, Maverick Sport, Maverick Sport MAX
715003656



FULL WINDSHIELD

- High-impact-resistant durable polycarbonate full windshield.
- Formed polycarbonate construction for enhanced rigidity.
- Seals firmly against the cage and protects rider and passenger from the elements.
- Formulated to be non-yellowing, non-crazing, non-cracking with excellent UV resistance and optical clarity.
- Must be used with rear wind protection.
- Quick and easy tool-less installation or removal.

Maverick Trail, Maverick Sport, Maverick Sport MAX
715003655



EXPERT CHOICE

PROVENT WINDSHIELD

- High-impact-resistant Quantum¹ hardcoated polycarbonate full windshield.
- Controllable vents to manage air flow.
- Channels air into the cabin, defogs windshield, fully closes to eliminate air flow.
- One upper vent and one lower vent with pre-filters.
- Provides excellent optical clarity and better abrasion resistance.
- Protects driver and passenger from the elements.
- Quick and easy tool-less installation or removal.
- Not compatible with Lonestar racing roofs, wiper kits or wet sounds stealth 6 Ultra HD Can-Am edition sound bar.

Maverick Trail, Maverick Sport, Maverick Sport MAX
715005210

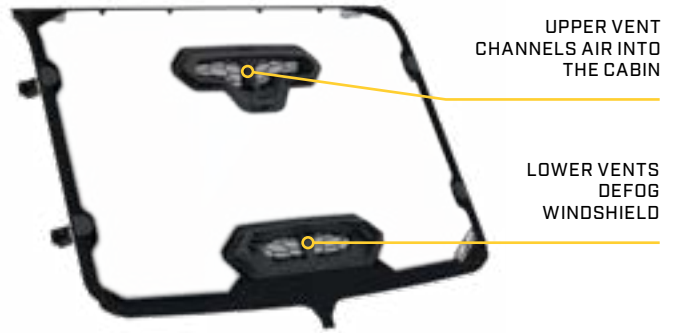

SIDE WINDSHIELD DEFLECTORS

- Clear polycarbonate air deflectors mount on each side of the cage.
- Not compatible with full doors.
- Sold in pairs.
- Compatible with all windshields.

Maverick Trail, Maverick Sport, Maverick Sport MAX
715004310

Can be adjusted at three different positions for cabin air flow control when a full windshield is installed:

- 1) Outside deflection to reduce cabin air flow and turbulence.
- 2) Inside deflection to increase air flow in the cabin.
- 3) Windshield ventilation to reduce fog.

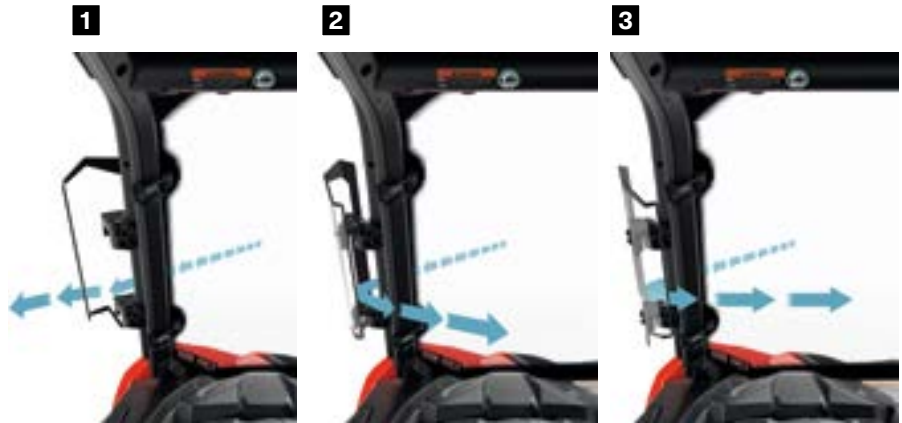

HALF WINDSHIELD

- Formed polycarbonate construction for enhanced rigidity.
- Formulated to be non-yellowing, non-crazing, non-cracking with excellent UV resistance and optical clarity.
- Protects driver and passenger from the elements.
- Features reverse angle lip to deflect air flow.
- Quick and easy tool-less installation or removal.

Maverick Trail, Maverick Sport, Maverick Sport MAX

CLEAR

715003657



TINTED

715005280



SIDE MIRRORS

- Rugged black nylon ¾ construction with coated cast-aluminum mount.
- Dual adjustment (horizontal and vertical) will suit any rider.
- Convex optics deliver optimal field of view (FOV).
- Spring-loaded pivots let mirrors fold back completely.
- Sold in pairs.

Maverick Trail, Maverick Sport, Maverick Sport MAX
715003639



EXPERT CHOICE

REAR VIEW MIRROR AND CAMERA MONITOR

- Fully waterproof rearview camera and monitor kit.
- Multi-angle camera provides real-time image of the cargo area, and of course, a view of the rear.
- Unit replaces stock rearview mirror (screen is integrated in the unit's replacement rearview mirror).
- Camera uses infrared light for night vision capabilities.

Maverick Trail, Maverick Sport, Maverick Sport MAX
715004905 • Black



PANORAMIC CENTER MIRROR

- Wide-angle convex mirror.
- Offers enhanced visibility.
- Can be used with or without roof or windshield.

Maverick Trail, Maverick Sport, Maverick Sport MAX
715003638



SPORT PANORAMIC CENTER MIRROR

- Convex mirror for wide rearward visibility.
- Ball-joint design with tightening knob for steady multi-angle adjustment.
- Can be used with or without roof or windshield.
- Not for road use.

Maverick Trail, Maverick Sport, Maverick Sport MAX
715004924



DOORS

DEVELOPED TOGETHER WITH YOUR MAVERICK SPORT AND MAVERICK TRAIL. COMFORT, PROTECTION AND GREAT LOOKS BUILT TO OUTLAST ANY TRAIL.

**100%
integrated**

All our doors seamlessly integrate with your vehicle.

TOOL-LESS REMOVAL
Once installed, our upper soft doors are easy to remove on hot and sunny days.



UPPER SOFT DOOR PANELS

Quickly open up or enclose the cockpit with zippered windows made from robust laminated, polished vinyl.



BEST PROTECTION FROM THE ELEMENTS

Can-Am doors seal with a frame that sits firmly against the cage.



TRAIL HALF DOORS

- Half doors made of molded polypropylene to match vehicle's styling.
- Steel frame for high level of rigidity.
- A must-have for additional cabin comfort.
- Keep the vehicle narrow in tight trail riding conditions.
- Door Trim is required to complete your door kit (sold separately).
- Standard on 1000 Base and 1000 DPS models.
- Sold in pairs.

Maverick Trail
715004418



DOOR TRIM

- Matching colored panel for Trail Half Doors.
- Required to complete the Trail Half Doors (sold separately).
- Sold in pairs.

Maverick Trail

- 715004802 • White
- 715005083 • Sunburst Yellow
- 715006104 • Can-Am Red

SPORT HALF DOORS

- Half doors made of molded polypropylene to match vehicle's styling.
- A must-have for additional cabin comfort.
- Features rounded shape to increase cabin space.
- Standard on all Maverick Sport models.
- Can be installed on Maverick Trail models for additional cabin space.
- Door Trim is required to complete your door kit (sold separately).
- Sold in pairs.

Maverick Trail, Maverick Sport, Maverick Sport MAX
715006217



DOOR TRIM

- Matching colored panel for the Sport Half Doors.
- Required to complete the Sport Half Doors (sold separately).
- Sold in pairs.

Maverick Trail, Maverick Sport, Maverick Sport MAX

- 715006216 • Carbon Black
- 715006105 • Can-Am Red

**EXPERT
CHOICE****UPPER SOFT DOOR PANELS**

- Upper canvas portion of the doors with sturdy steel frame.
- Seal firmly against the cage and protect rider and passenger from the elements.
- Convert half door into full door for a complete cab enclosure.
- Zippered window made of laminated polished vinyl material for added ventilation.
- Easy to remove on hot and sunny days.
- Must be used with the Sport Roof.

Maverick Trail, Maverick Sport

- Can be installed on the Maverick Trail equipped with the Sport Half Doors or with the standard half doors on Maverick Sport models.
- Not compatible with Trail Half Doors or with the standard half doors on Maverick Trail models.

715004718**Maverick Sport MAX**

- Include Upper Soft Door Panels for front and rear doors.

715004727**Maverick Trail**

- Can only be installed with Trail Half Doors or with the standard half doors on Maverick Trail models.
- Not compatible with Sport Half Doors or with the standard half doors on Maverick Sport models.

715003620**DOOR SEAL KIT**

(Not illustrated)

- Improves door sealing from the elements and provides additional cabin comfort.
- Included in the Soft Cab Enclosure kit (715003618).
- Not compatible with Sport Half Doors.
- Compatible with the Trail Half Doors or with the stock doors on the Maverick Trail.

Maverick Trail**715004773****DOOR KNEE PADS WITH STORAGE**

- Padded door cushion with integrated pocket for storage.
- Protect driver and passenger legs from direct contact with the doors while riding.
- Increase cabin comfort.
- Require Trail Half Door on 800 Base and 800 DPS models (715004418).
- Offer storage space for small items.
- Sold in pairs.
- Not compatible with Sport Half Doors.

Maverick Trail**715003635****DOOR STORAGE WITH PADDING**

- Weather-resistant door storage bags with integrated padding.
- Holds your gear safely and securely and also protects driver and passenger legs from direct contact with the doors while riding.
- Each bag is designed as a 0.5 Gal (2 L) capacity pocket also equipped with inner netting compartments.
- Semi-rigid construction renders them flexible enough to fit odd-shaped loads.
- Easy to install.
- Sold in pairs.
- Bags attach on stock doors of the Maverick Sport or on the Maverick Trail equipped with the Sport Half Doors (715005295).
- Not compatible with stock doors on the Maverick Trail or the Trail Half Doors.

Maverick Trail, Maverick Sport, Maverick Sport MAX**715004914**

REAR WIND PROTECTION

STAY CLEANER AND WARMER WHILE RIDING THROUGH THE WORST.



REAR POLYCARBONATE WINDOW

- High-impact-resistant polycarbonate window.
- Blocks windshield backdraft or dust and rain from entering for added cabin comfort.
- Sport Roof (715006218 or 715004704 for MAX) is required for installation.
- Not compatible with Bimini Roof with Sun Visor, Dragonfire Aluminum Roof and Lonestar Racing Aluminum Roof.

Maverick Trail, Maverick Sport, Maverick Sport MAX (except X mr models)
715006113

SOFT REAR PANEL

- Plastic reinforced and weather-resistant rear panel offers good protection from the elements.
- Made of heavy-duty UV-resistant solution-dyed polyester canvas for excellent resistance to tear and abrasion.
- Clear window made of laminated polished vinyl material.
- Resists cold cracking.
- Installs quick and easily on roll cage.

Maverick Trail, Maverick Sport, Maverick Sport MAX (except X mr models)
715005887

REAR WIND SCREEN

- Full rear mesh screen reduces windshield backdraft for added cabin comfort.
- Installs quick and easily on roll cage.
- Large Can-Am branding.

Maverick Trail, Maverick Sport, Maverick Sport MAX (except X mr models)
715003664



EXPERT CHOICE

HMWPE SKID PLATES

Our Plastic Plates glide smoothly and silently over obstacles, offering great protection in rough terrain. Made of abrasion-resistant thermoformed 3/8" (10 mm) thick High Molecular Weight Polyethylene (HMWPE).

- ✓ Lighter than aluminum
- ✓ Superior stress crack resistance
- ✓ High impact strength

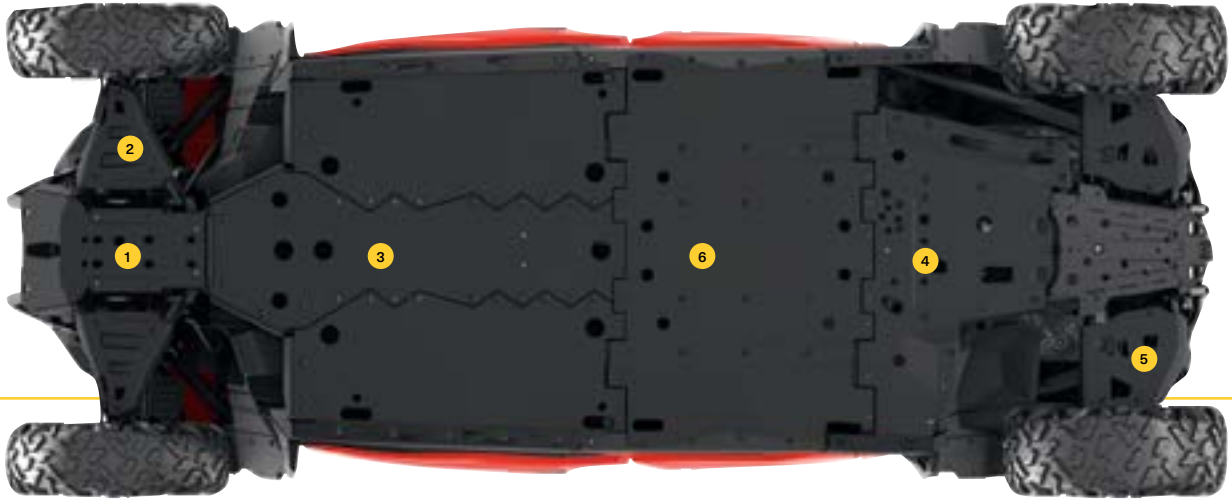

MAVERICK SPORT & MAVERICK SPORT MAX					MAVERICK TRAIL
2019		2020-2021		ANY YEAR	
Base & DPS	X mr	Base & DPS	X mr & X xc	X rc	

FULL PROTECTION KIT						
HMWPE Skid Plate Protection kit	715006348 (except Max)	715006353	715006349 (except Max)	715006350	—	715006346 (2019 & prior)
	715006352 (Max only)		715006351 (Max only)			715006347 (2020)

INDIVIDUAL HMWPE SKID PLATES						
1	HMWPE Front Skid Plate	715004260	715004260	715004260	715004260	(Standard on X rc models) 715004260
2	HMWPE Front A-Arm Protectors	715004270	715006340	715004270	715006340	(Standard on X rc models) 715003698
3	HMWPE Underbelly Plates - Keep the rollover clearance.	715006339	715006339	715006273	715006273	715006339 (2019) 715006339 (2019 & prior)
						715006273 (2020) 715006273 (2020)
4	HMWPE Rear Skid Plate	715004261	715004261	715004261	715004261	715004261
5	HMWPE Rear A-Arm Protectors	715004271	715006341	715004271	715006341	(Standard on X rc models) 715003699
6	HMWPE Central Skid Plate	715004272 (Max only)	—	715004272 (Max only)	—	—

BUMPERS

THE STRENGTH TO ENDURE AND THE CHARACTER TO WEAR WELL
- OUR BUMPERS ARE READY FOR IT.



BETTER CORROSION PROTECTION

Can-Am bumpers are E-Coated
for excellent corrosion protection inside and out.



LIGHT READY

Fully Integrated light mounting plate.
Multiple light installation option.



EXPERT CHOICE

FRONT TRAIL BUMPER

- Front bumper made of heavy-duty 1.5" (3.8 cm) diameter steel tubing.
- Completes the stock bumper for more front coverage and essential vehicle protection for trail riders.
- Inside and outside anti-corrosion coating with durable powder coat finish.
- Includes integrated mount points for seamless light installation.

Maverick Trail, Maverick Sport, Maverick Sport MAX

- 715003680 • Black
- 715003681 • Sunburst Yellow



REAR TRAIL BUMPER

- Rear bumper made of heavy-duty 1.5" (3.8 cm) diameter steel tubing.
- Protects vehicle bodywork and exhaust system.
- Inside and outside anti-corrosion coating with durable powder coat finish.

Maverick Trail, Maverick Sport, Maverick Sport MAX

- 715007109 • Black (EC Compliant)
- 715003684 • Sunburst Yellow



NEW LICENSE PLATE HOLDER

- Supports your license plate on the Rear Trail Bumper.
- Require Rear Trail Bumper (715007109) for installation
- Plate lights can be relocated on bumper to light up license plate.
- CE compliant

**Maverick Trail,
Maverick Sport,
Maverick Sport MAX**
715007006





FRONT
INTRUSION
BAR

FRONT
CORNER
PROTECTORS

ROCK
SLIDERS

FRONT CORNER PROTECTORS

- Heavy-duty 1.5" (3.8 cm) diameter steel tubing.
- Inside and outside anti-corrosion coating with durable powder coat finish.
- Provide additional protection for vehicle's front corners.
- Require Front Trail Bumper (715003680/715003681) for installation (not compatible with the Front Rancher Bumper).
- Sold in pairs.

Maverick Trail, Maverick Sport, Maverick Sport MAX

■ 715004912 • Black

■ 715005230 • Sunburst Yellow



FRONT INTRUSION BAR

- Steel intrusion bar matches perfectly with vehicle's styling.
- Inside and outside anti-corrosion coating with durable powder coat finish.
- Provides additional protection by preventing large objects from entering the driver/passenger area.
- Tube design reduces obstructed lines of sight and blind spots for better visibility.
- Not compatible with windshields and Upper Soft Door Panels.

Maverick Trail, Maverick Sport, Maverick Sport MAX

715003872



RANCHER FRONT BUMPER

- Heavy-duty protection made of 1.5" (3.8 cm) diameter steel tubing, perfect for farm, ranch and forestry applications.
- Inside and outside anti-corrosion coating with durable powder coat finish.
- Offers full front coverage and superior headlight protection.
- Removable radiator protector to allow light installation.
- Rugged look.
- Not EC compliant.

Maverick Trail, Maverick Sport, Maverick Sport MAX

715004303



RANCHER REAR BUMPER

- Heavy-duty protection made of 1.5" (3.8 cm) diameter steel tubing, perfect for farm, ranch and forestry applications.
- Inside and outside anti-corrosion coating with durable powder coat finish.
- Offers full rear coverage with integrated tail light protectors.
- Not EC compliant.

Maverick Trail, Maverick Sport, Maverick Sport MAX

715004304





TAIL LIGHT PROTECTORS

ROCK SLIDERS

- Made of heavy-duty 1.5" (3.8 cm) diameter steel tubing.
- Inside and outside anti-corrosion coating with durable powder coat finish.
- Protect vehicle's rocker panels and undercarriage against large obstacles.
- Sold in pairs.

Maverick Trail, Maverick Sport (except X rc)

- 715003689 • Black
- 715005228 • Sunburst Yellow

Maverick Sport MAX

- 715004754 • Black



TAIL LIGHT PROTECTORS

- Anti-corrosion coating with durable powder coat finish.
- Rugged style, aggressive look.
- Sold in pairs.
- Not EC compliant.

Maverick Trail, Maverick Sport, Maverick Sport MAX
715003692



2" (51 MM) FENDER FLARES

- Extended fender flares made from injection-molded polypropylene.
- Keep mud and debris out of vehicle.
- Designed for quick and easy installation.
- Include front and rear extensions, mounting hardware and Fender Flare Rear Extensions (715004404).
- Increase vehicle's overall width by 3.5" (8.9 cm).

Maverick Trail

715004958



FENDER FLARE REAR EXTENSIONS

- Help tail light stay clean from debris and mud to remain visible. Can be installed with 2" (51 mm) Fender Flares (715003625) or with the standard fender flares on Maverick Sport models to keep mud and debris out of cargo area.
- Made from injection-molded polypropylene for best fit and finish.
- Sold in pairs.
- Included with the 2" (51 mm) Fender Flares (715004958) and with the Fender Flare Extensions (715004462).

Maverick Trail, Maverick Sport, Maverick Sport MAX
715004404





3" (76 MM) FENDER FLARES

3" [76 MM] FENDER FLARES

- Fender flares made from injection-molded polypropylene.
- Keep mud and debris out of vehicle.
- Designed for quick and easy installation.
- Include front and rear extensions and mounting hardware.
- Increase vehicle's overall width by 6" (15.3 cm) when installed on Maverick Trail models.
- Standard on Maverick Sport models.

Maverick Trail, Maverick Sport, Maverick Sport Max
715004959

FENDER FLARE EXTENSIONS

- Block terrain debris from kicking up onto you as you ride or damaging your vehicle thanks to these extra-large Fender Flare Extensions, which also include rear extensions (715004404) for added protection from mud/snow, especially when riding with track kits.
- Made from injection-molded polypropylene for best fit and finish.
- Not compatible with 2" (51 mm) Fender Flares.
- Include front and rear extensions.
- For Maverick Trail, must be used with 3" (76 mm) Fender Flares (715004959).
- Standard on Maverick Sport X mr models.

Maverick Trail, Maverick Sport, Maverick Sport MAX
715004462



RADIATOR PROTECTOR

- Perforated steel shield mounted over the radiator face, providing protection from stones and branches.
- Not recommended for winter use.

Maverick Trail, Maverick Sport, Maverick Sport MAX
715003700

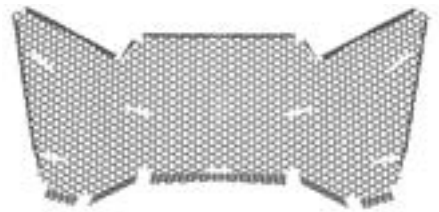
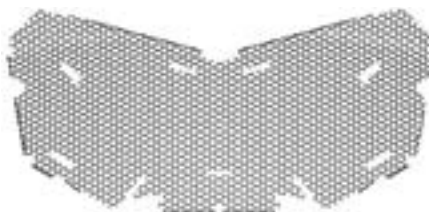



LONESTAR RACING FRONT INTRUSION BAR

LONESTAR RACING ROCK SLIDERS

LONESTAR RACING FRONT BUMPER



PEAK PERFORMANCE NEVER LOOKED SO HOT.

RACE-ENGINEERED WITH A REPUTATION FOR TOUGHNESS AND STYLE, LONESTAR RACING ACCESSORIES PLAY JUST AS HARD AS YOU WANT TO.

LONESTAR RACING FRONT BUMPER

- Race-engineered to Lonestar Racing's trademark standards for toughness, these stylishly crafted accessories will also enhance your vehicle with visual impact.
- Made of 1.5" (3.8 cm) diameter steel tubing with durable powder coat finish.
- Billet End Cap with Lonestar Racing logo.
- Compatible with synthetic rope winches and Hawse Fairlead.

Maverick Trail, Maverick Sport, Maverick Sport MAX

- 715005131 • Black
- 715004871 • Can-Am Red

LONESTAR RACING REAR BUMPER

- Race-engineered to Lonestar Racing's trademark standards for toughness, these stylishly crafted accessories will also enhance your vehicle with visual impact.
- Made of 1.5" (3.8 cm) diameter steel tubing with durable powder coat finish.
- Billet End Cap with Lonestar Racing logo.
- Provides additional vehicle-rear bodywork and exhaust system protection in extreme driving conditions.

Maverick Trail, Maverick Sport, Maverick Sport MAX

- 715005133 • Black
- 715004873 • Can-Am Red



LONESTAR RACING FRONT INTRUSION BAR

- Race-engineered to Lonestar Racing's trademark standards for toughness, these stylishly crafted accessories will also enhance your vehicle with visual impact.
- Made of 1.5" (3.8 cm) diameter steel tubing with durable powder coat finish.
- Provides additional protection for driver and passenger.
- Compatible with Lonestar Racing Aluminum Roof.
- Not compatible with windshields, Bimini Roof with Sun Visor and Sport Roof.

Maverick Trail, Maverick Sport, Maverick Sport MAX (2020 and prior)

- 715005132 • Black
- 715004872 • Can-Am Red



LONESTAR RACING REAR INTRUSION BAR

- Race-engineered to Lonestar Racing's trademark standards for toughness, these stylishly crafted accessories will also enhance your vehicle with visual impact.
- Made of 1.5" (3.8 cm) diameter steel tubing with durable powder coat finish.
- Provides additional protection for driver and passenger.
- Not compatible with the Sport Roof, rear panels and windows, All-Terrain Trunk Cover.
- Not compatible with X mr models or with the Snorkel kit.

Maverick Trail, Maverick Sport

Not compatible with S&B particle separator.

- 715005134 • Black
- 715004874 • Can-Am Red

Maverick Trail, Maverick Sport

Compatible with S&B particle separator (Not illustrated).

- 715005413 • Black
- 715005414 • Can-Am Red*

Maverick Sport MAX

Compatible with S&B particle separator. Not compatible with X mr package or with the Snorkel kit.

- 715005420 • Black
- 715005421 • Can-Am Red

715004874



715005420



LONESTAR RACING ROCK SLIDERS

- Race-engineered to Lonestar Racing's trademark standards for toughness, these stylishly crafted accessories will also enhance your vehicle with visual impact.
- Made of 1.5" (3.8 cm) diameter steel tubing with durable powder coat finish filled with 1/8" (3 mm) aluminum plate.
- Billet End Cap with Lonestar Racing logo.
- Protect vehicle sides from large obstacles.
- Sold in pairs.

Maverick Trail, Maverick Sport (except X rc)

- 715005135 • Black
- 715004875 • Can-Am Red

Maverick Sport MAX

- 715004893 • Can-Am Red



715005135



715004893



LONESTAR RACING SPARE TIRE HOLDER

- Race-conceived for riders who believe a Plan B means thinking like a pro.
- Holds wheel securely no matter how rough the trail.
- Made of 1.5" (3.8 cm) diameter steel tubing with durable powder coat finish.
- Easy, bolt-on installation on roll cage.
- Can accommodate tires up to 27".
- Wheel not included.
- Not compatible with All-Terrain Trunk Cover, Fixed Tailgate, LinQ Cargo Rack and LinQ Rack Extension.
- Not compatible with snorkel kit.

Maverick Trail, Maverick Sport, Maverick Sport MAX (except X mr)

- 715005136 • Black
- 715004876 • Can-Am Red

LONESTAR RACING NUMBER PLATE

- Race-bred in the Lonestar tradition of competition-level riding, this number plate will brand your vehicle a winner.
- Includes a pair of sturdy aluminum number plates.
- Create your personalized number decal through SCS Unlimited.
- Not compatible with the All-Terrain Trunk Cover.

Maverick Trail, Maverick Sport, Maverick Sport MAX

- 715004878





DRAGONFIRE FRONT BUMPER

- 1.5" (3.8 cm) diameter steel tubing with durable powder coat finish and reinforced with a 0,09" (2.3 mm) thick steel plate.
- Delivers additional protection for your vehicle.
- Sleek lines designed to match your vehicle's body and greatly enhance the overall look.
- Combines perfectly with the DragonFire Front Exo-Frame.
- Billet End Caps with DragonFire Logo.
- Not compatible with the Front Receiver Hitch.
- Includes brackets for auxiliary light mounting.

Maverick Trail, Maverick Sport, Maverick Sport MAX
■ 715004456 • Can-Am Red
■ 715005128 • Black



DRAGONFIRE REAR BUMPER

- 1.5" (3.8 cm) diameter steel tubing with durable powder coat finish and reinforced with a 0,09" (2.3 mm) thick steel plate.
- Delivers additional protection for your vehicle.
- Sleek lines designed to match your vehicle's body and greatly enhance the overall look.
- Billet End Caps with DragonFire Logo.

Maverick Trail, Maverick Sport, Maverick Sport MAX
■ 715004457 • Can-Am Red
■ 715005129 • Black



DRAGONFIRE FRONT INTRUSION BAR

- 1.25" (3.2 cm) diameter steel tubing with durable powder coat finish.
- Provides additional protection for driver and passenger.
- Unique design with a centered upper portion to minimize effects on visibility.
- Sleek lines designed to match your vehicle's body and greatly enhance the overall look.
- Not compatible with Bimini and Sport Roofs and Full windshields.

Maverick Trail, Maverick Sport, Maverick Sport MAX (2020 and prior)
■ 715004455 • Can-Am Red



DRAGONFIRE FRONT EXO-FRAME

- 1.5" (3.8 cm) diameter steel tubing with durable powder coat finish.
- Provides full front-corner and side-body protection.
- Sleek lines designed to match your vehicle's body and greatly enhance the overall look.
- DragonFire Front Bumper (715004456/715005128) is required for installation.
- Sold in pairs.

Maverick Trail, Maverick Sport, Maverick Sport MAX
■ 715004801 • Can-Am Red
■ 715005127 • Black



DRAGONFIRE ROCK SLIDERS

- 1.25" (3.2 cm) diameter steel tubing with durable powder coat finish.
- Sleek lines designed to match your vehicle's body and greatly enhance the overall look.
- Protect vehicle's undercarriage with minimal effect on ground clearance.
- 0,09" (2.3 mm) steel plate wraps the lower side of the vehicle for additional lateral protection.
- Sold in pairs.

Maverick Trail, Maverick Sport (except X rc)
■ 715003690 • Can-Am Red
■ 715005130 • Black

Maverick Sport MAX
■ 715005160 • Black





DRAGONFIRE SPARE TIRE HOLDER

- 1.5" (3.8 cm) diameter steel tubing with durable powder coat finish.
- Sleek lines designed to match your vehicle's body and greatly enhance the overall look.
- Easy-to-install roll cage mounted spare-tire holder.
- Accommodates tires up to 28" in diameter (wheel not included).
- Uses standard bolt pattern for wheel installation.
- Not compatible with LinQ pivoting rack (715004708), All-Terrain Trunk Cover, Gear Rail and accessories mounted in the cargo bed.

Maverick Trail, Maverick Sport, Maverick Sport MAX (except X mr models)

■ 715004443 • Can-Am Red

■ 715005125 • Black



WHEN IT COMES TO MUD-MASTERING ACCESSORIES, S3 HAS THE EDGE IN DELIVERING PERFECT-FIT WINCH-READY BUMPERS FOR WORK, PLAY, AND RECOVERY.

S3 FRONT BUMPER

- Made of extra durable 1.5" (3.8 cm) diameter steel tubing.
- Inside and outside anti-corrosion coating with durable powder coat finish.
- Replaces stock bumper and adds superior protection for mud-riding enthusiasts.
- Integrated mount points for lights.
- Hook support anchor allows you to keep the winch hook within easy reach when riding in deep mud.
- "S3 for Can-Am" branded.
- Winch not included.

Maverick Sport, Maverick Sport MAX, Maverick Trail

■ 715005121 • Black

■ 715004880 • Sunburst Yellow

REAR WINCH HARNESS

(Not illustrated)

715006008

S3 REAR BUMPER

- Made of extra durable 1.5" (3.8 cm) diameter steel.
- Inside and outside anti-corrosion coating with durable powder coat finish.
- Added heavy-duty protection in extreme driving conditions – protects vehicle bodywork and exhaust system.
- Permits installation of a winch at a higher location to improve accessibility in mud-riding conditions.
- Engineered to sustain heavy winch loads without damaging the vehicle's frame.
- Compatible with Can-Am HD and WARN VRX winches – Rear Winch Harness 715006008 is required to install a winch on the bumper.

- Includes a License Plate Support Mount.
- Not EC Compliant
- "S3 for Can-Am" branded.
- Winch not included.

Maverick Sport, Maverick Sport MAX, Maverick Trail

■ 715005122 • Black

■ 715004881 • Sunburst Yellow



SEAT ACCESSORIES

RACE-INSPIRED
4-POINT HARNESSES SECURE
RIDERS FOR INCREASED BALANCE,
FOCUS AND COMFORT.

4-POINT HARNESS

- Exclusive controlled decelerator technology (patent pending) absorbs additional energy in case of an accident.
- Designed to offer maximum riding comfort.
- Easy one-click latch and release.
- Not EC compliant.
- ROHVA compliant.
- 4-Point Harness Bar is required for front seat on Max models.

Maverick Trail, Maverick Sport,
Maverick Sport MAX

715008035 • Driver

715008036 • Passenger



4-POINT HARNESS BAR

- Allows you to install 4-point harnesses on the front passenger and driver seats of a Maverick Sport Max.
- 4-point harnesses need to be installed for both driver and front passenger seats when the 4-Point Harness Bar is installed.

Maverick Sport MAX

715004847



SEAT BELT SHOULDER PADS

- Provide additional riding comfort by preventing seat belt from rubbing on neck and shoulder.
- Fit with standard 3-point seat belts.
- Easy Velcro installation.
- Can-Am branded.
- Sold in pairs for driver and passenger.

Maverick Trail,
Maverick Sport,
Maverick Sport MAX
715002894



EASY ON, EASY OFF CARGO



A BRP EXCLUSIVE, LinQ IS A TOOL-LESS SYSTEM FOR NEAR-INSTANT INSTALLATION OF ACCESSORIES. QUICKLY, EASILY INSTALL AND REMOVE LinQ ACCESSORIES TO TRANSFORM YOUR MACHINE TO FIT THE MOMENT.



LinQ PASSENGER SEAT BASE KIT

Quickly lock & load LinQ accessories in place of a passenger seat when traveling solo, hunting, and in need of secure, easy-to-access additional space.



TOOL-LESS

Twist LinQ fasteners and go!

LinQ ACCESSORY TYPES







- **LinQ** with 16" base accessories are mounted with LinQ anchors 16 inches apart, ideal for Can-Am ATVs and SSVs, Sea-Doo watercraft, and Ski-Doo snowmobiles.
- **LinQ** with 36" base accessories are most commonly used as part of LinQ racks for Can-Am Off-Road vehicles.



LinQ SYSTEM™ ACCESSORIES





- No tools needed: Quickly install and remove accessories by hand
- Equip your Can-Am for specialized tasks in no time
- Sturdy mounting system that holds up to the roughest terrain

MOUNTING LOCATION AND REQUIREMENTS

Vehicle Standard Cargo Box	Passenger Seat Base	LinQ Cargo Rack 715003702	LinQ Pivoting Rack 715004708	Adventure Roof Rack 715004095	All-Terrain Trunk Cover 715003701
					









LinQ ACCESSORIES WITH 16" BASE p.37

- LinQ anchors mounted 16 inches apart, center-to-center.
- Lower loading capacity than the LinQ with 36" base accessories.
- Can be used on Can-Am ATV and SSV vehicles, Sea-Doo watercraft and Ski-Doo snowmobiles.

 LinQ 4.2 GAL (16 L) COOLER 219400964 • Black 295100698 • White	LinQ Anchor kit 860201806 + LinQ Anchor Installation kit 715007304				LinQ Anchor kit 860201806	LinQ Anchor kit 860201806
 LinQ TOOL BOX 715004301	LinQ Anchor Installation kit 715007304	Passenger Seat LinQ Anchor kit 715003951	Not compatible	LinQ Anchor Adapter kit 715004960	No further requirements	No further requirements
 LinQ SR 5.5 GAL (21 L) BAG 860201740						
 LinQ 4.5 GAL (17 L) SPORT BAG 860201678						
 LinQ DRY BAG 715002875						

LinQ ACCESSORIES WITH 36" BASE p.39

- Mount on LinQ racks often used by Can-Am ORV vehicles.
- Higher loading capacity than the LinQ with 16" base accessories.
- Usage is limited to Can-Am ORV vehicles.

 LinQ 12 GAL (45 L) CARGO BOX 715003879						
 LinQ 23 GAL (86 L) TRUNK BOX 715004923					No further requirements	
 LinQ 32 GAL (121 L) TRUNK BOX 715001747					No further requirements	
 LinQ 11.5 GAL (43 L) AUDIO CARGO BOX 715003018					No further requirements	
 LinQ 8 GAL (30 L) COOLER BOX 715004778 • Black / 715004698 • Grey	Not compatible	Not compatible		Not compatible	No further requirements	Not compatible
 LinQ PREMIUM STORAGE BAG BY OGIO 715002923 • Black / 715003248 • Camo					No further requirements	
 LinQ HEAVY-DUTY BASKET 715001215					No further requirements	
 LinQ LOW PROFILE BASKET 715004282					No further requirements	

LinQ RACKS & HOLDERS p.43

 LinQ TOOL HOLDER 715003059	No further requirements (when installed on side walls)	No further requirements	Not compatible	No further requirements	Side wall installation: LinQ Adapters 715003058	Not compatible
---	--	-------------------------	----------------	-------------------------	--	----------------



EXPERT CHOICE

LinQ 4.2 GAL (16 L) COOLER

- Rotomolded construction for exceptional rigidity and durability.
- Premium-quality foam insulation for optimal ice retention.
- Maritized for salt water purposes.
- See table for installation location and requirements.

Maverick Trail,
Maverick Sport,
Maverick Sport MAX
219400964 • Black
295100698 • White



LinQ SR 5.5 GAL (21 L) BAG

- Semi-rigid expandable bag.
- 5.5 Gal (21 L) capacity.
- LinQ Cargo Base kit (860201806) included.
- See table for installation location and requirements.

Maverick Trail,
Maverick Sport,
Maverick Sport MAX
860201740



LinQ PASSENGER SEAT BASE KIT

- LinQ base kit that installs on the passenger seat frame underneath the bottom seat cushion.
- Allows installation of compatible LinQ accessories inside the cabin.
- Passenger seat cushion can be reinstalled over the LinQ base kit when not in use.

Maverick Trail, Maverick Sport,
Maverick Sport MAX
715003951



LinQ 4.5 GAL (17 L) SPORT BAG

- 4.5 Gal (17 L) capacity.
- Rigid bottom, semi-rigid top.
- See table for installation location and requirements.

Maverick Trail,
Maverick Sport,
Maverick Sport MAX
860201678



LinQ CARGO BASE KIT

- Allows installation of compatible LinQ accessories.
- Included: 2 LinQ Cargo bases and hardware.

Maverick Trail, Maverick Sport,
Maverick Sport MAX
860201806



LinQ TOOL BOX

- High precision injected HDPE construction provides rigidity and durability.
- 5 Gal (19 L) maximum capacity.
- Weather-resistant, sealed and lockable cover.
- LinQ Cargo Base kit (860201806) included.
- Maritized for salt water purposes.
- See table for installation location and requirements.

Maverick Trail,
Maverick Sport,
Maverick Sport MAX
715004301



LinQ REPLACEMENT PART

- Sold in pairs.

Maverick Trail, Maverick Sport,
Maverick Sport MAX
715001707



LinQ ANCHOR ADAPTER KIT

- Allows the installation of LinQ accessories with 16" base on LinQ racks.
- Tool-less installation and removal.
- LinQ pivoting rack (715004708) is required for installation.

Maverick Trail, Maverick Sport,
Maverick Sport MAX
715004960



LinQ DRY BAG

- Fully waterproof roll-top dry bag will securely store and confine your equipment.
- LinQ mounted using heavy-duty rigid plastic base.
- High capacity storage solution (40 L).
- Bottom foam liner for additional equipment protection.
- Integrated handle for easy transportation on/off vehicle.
- LinQ Cargo Base kit (860201806) included.
- Maritized for salt water purposes.
- See table for installation location and requirements.

Maverick Trail,
Maverick Sport,
Maverick Sport MAX
715002875



LinQ BASE INSTALLATION KIT

(Not illustrated)

- Required to install LinQ Cargo Base kit in cargo box.

Maverick Trail, Maverick Sport,
Maverick Sport MAX
715007304



LinQ Accessories with 36" base 

LinQ PREMIUM STORAGE BAG BY OGIO

- Tool-less installation and removal thanks to the LinQ System.
- 17.2 Gal (65 L) capacity semi-rigid cargo bag ideal for carrying anything you need on your vehicle.
- Buckle and elastic closure with a rubber seal that protects dust from entering the bag.
- 3-section lid for partial or full access to your bag.
- Inside separators for optimal bag organization.
- See table for installation location and requirements.

Maverick Trail, Maverick Sport, Maverick Sport MAX

■ 715002923 • Black

■ 715003248 • Mossy Oak Break-Up Country Camo



INSIDE SEPARATORS FOR OPTIMAL BAG ORGANIZATION

LinQ 8 GAL (30 L) COOLER BOX

- Installs without vehicle modification.
- LinQ mounted for easy on, easy off installation.
- Rotomolded construction provides exceptional rigidity and durability.
- Premium-quality foam insulation for optimal ice retention.
- Integrated, fully-removable compartment protects food.

- Robust rubber latches keep the cover tightly closed.
- Weather-resistant
- Convenient drain plug.
- See table for installation location and requirements.

Maverick Trail, Maverick Sport, Maverick Sport MAX

■ 715004698 • Grey

■ 715004778 • Black



LinQ 11.5 GAL (43 L) AUDIO CARGO BOX

- An affordable and quick solution for adding music and storage to your next ride.
- The rear installation does not use up any cab space and allows easy listening at an average speed.
- Mounts on/off easily to hold/carry cargo safely and securely.
- Backlit control panel perfect for night riding.
- Water-resistant speakers.
- The Bluetooth enabled receiver and 6.5" (16.5 cm) speakers are smartly concealed and integrated in the cover.
- Automatic shut-off function protects your battery by turning the system off after 10 minutes of inactivity.
- See table for installation location and requirements.

Maverick Trail, Maverick Sport, Maverick Sport MAX

715003018





LinQ 32 GAL (121 L) TRUNK BOX

- Equipped with the LinQ System, the rear trunk box plugs in and out in seconds.
- 32 Gal (121 L) load capacity with unobstructed space to maximize storage room and access to the trunk's interior.
- Made of injection-molded polyethylene, double walled in critical areas.
- The fully sealed lid protects your belongings from dust, moisture and the elements.
- Trunk Box Panels available in many colors to match your vehicle (sold separately).
- See table for installation location and requirements.

Maverick Trail, Maverick Sport, Maverick Sport MAX

715001747 • Black (Rear tail light included)

European Version (EC compliant)

715001748 (No rear tail light)



LinQ 32 GAL (121 L) TRUNK BOX PANELS

- Color panels to match the LinQ 32 Gal (121 L) to your vehicle.

Maverick Trail, Maverick Sport, Maverick Sport MAX

- 715001391 • Black
- 715001392 • Yellow
- 715001395 • Viper Red
- 715002481 • White
- 715002480 • Light Grey
- 715002984 • Octane Blue
- 715002985 • Manta Green
- 715002986 • Can-Am Red
- 715006119 • Orange Crush
- 715006120 • Squadron Green
- 715007074 • Tundra Green

European Version (EC compliant)

- No rear tail light
- 715001397 • Black
- 715001398 • Yellow
- 715002482 • Light Grey
- 715002483 • White
- 715006121 • Can-Am Red
- 715006122 • Manta Green
- 715006123 • Orange Crush
- 715006124 • Viper Red

LinQ 23 GAL (86 L) TRUNK BOX

- LinQ mounted for easy on, easy off installation.
- Lockable and weather-resistant.
- Holds cargo safely and securely while riding.
- See table for installation location and requirements.

Maverick Trail, Maverick Sport, Maverick Sport MAX

715004923



LinQ 12 GAL (45 L) CARGO BOX

- LinQ mounted for easy on, easy off installation.
- Holds cargo safely and securely while riding.
- See table for installation location and requirements.

Maverick Trail, Maverick Sport, Maverick Sport MAX

715003879



LinQ HEAVY-DUTY BASKET

- Made of high-strength, low-alloy steel.
- LinQ mount for easy on, easy off installation.
- See table for installation location and requirements.

Maverick Trail, Maverick Sport, Maverick Sport MAX

715001215



LinQ LOW PROFILE BASKET

- Low profile, open basket increases cargo space.
- Perfect for easy access to tools, rope, winch and plow accessories.
- Multiple bungee cord and tie-down anchor points.
- Made of impact-resistant injected polypropylene.
- See table for installation location and requirements.

Maverick Trail, Maverick Sport, Maverick Sport MAX

715004282



CARGO & STORAGE

GIVE YOUR CAN-AM
THE CARGO CAPACITY
TO CARRY THE LOAD
- ANYWHERE.

ALL-TERRAIN
TRUNK COVER



EXPERT CHOICE

ALL-TERRAIN TRUNK COVER

- Transforms your rear cargo area into a fully enclosed and weather-resistant car-like trunk box.
- Gas spring assisted opening.
- Integrated mounting location inside the trunk cover for Dome Light (715002455) (sold separately).
- Rotomolded construction provides exceptional rigidity.
- LinQ accessories can be installed on or inside the trunk cover.
- LinQ Cargo Base kit (860201806) required for installation on the trunk cover.

Maverick Trail, Maverick Sport (except X mr), Maverick Sport MAX
715003701



FIXED TAILGATE

- Rigid rotomolded construction.
- Encloses perfectly the rear cargo opening and helps cargo securely in place.
- Matches the vehicle's styling.

Maverick Trail, Maverick Sport, Maverick Sport MAX
715004357



REMOVABLE CENTRAL STORAGE BAG

- Weather-resistant bag, holds your gear safely and securely while riding.
- Both front and rear passengers can access the bag's content.
- Designed as a 1.3 Gal (5.2 L) capacity pocket, also equipped with inner netting compartments and side pockets.
- Can be removed in seconds and includes shoulder strap for transportation.
- Perfect to bring your gear on and off your vehicle.

Maverick Sport MAX
715004794



SHOULDER STORAGE BAG

- Weather-resistant semi-rigid bag, holds your gear safely and securely while riding.
- Bag attaches in unused space between the seats to increase your vehicle's cargo capacity.
- 2.8 Gal (10.5 L) capacity.

Maverick Trail,
Maverick Sport,
Maverick Sport MAX
715005019



OVERHEAD STORAGE BAGS

- Weather-resistant bags, hold your gear safely and securely while riding.
- Include 2 overhead soft bags mounted on a tubular frame that sits between cage and roof.
- 2.4 Gal (9 L) total capacity.
- Bimini Roof with Sun Visor or sport roof needed for installation.

Maverick Trail, Maverick Sport, Maverick Sport MAX
715005018



SOFT COOLER

- Soft cooler made of durable canvas.
- Removable shoulder strap and carry handles.
- Foam insulation and water-resistant interior liner.
- 2.2 Gal (4.5 L) capacity.

Maverick Trail, Maverick Sport,
Maverick Sport MAX
715003728



STORAGE 2.6 GAL (10 L) BAG

- Roll-top dry bag for fully protecting your cargo from the elements.

Maverick Trail, Maverick Sport,
Maverick Sport MAX
269502121



SOFT STORAGE BAG

(Not illustrated)

- 11.8 Gal (45 L) capacity soft cargo bag designed with vehicle's rear in mind to maximize potential storage.
- 3 sections.
- Weatherproof.

Maverick Trail, Maverick Sport, Maverick Sport MAX
■ 715003759 • Black

RACKS & HOLDERS

LinQ TOOL HOLDER
p. 45

SPARE TIRE RATCHET TIE-DOWNS

LinQ TOOL BOX
p. 38

LinQ 4.2 GAL (16 L) COOLER
p. 38

39" (99 CM) DOUBLE STACKED LED LIGHT BAR (270 WATTS)
p. 48

ADVENTURE ROOF RACK

- Ideal cargo solution for packing everything you need to live your Off-Road experience fully and completely.
- Built with heavy-duty 1.5" (3.8 cm) and 1.25" (3.2 cm) diameter steel tubing.
- Loads of up to 75 lb (34 kg).
- LinQ support plates allow for installation of LinQ accessories with 16" base.
- Integrated mounting points for the installation of the 39" (99 cm) Double Stacked LED Light Bar (front).
- Features anchor points for spare tire attachment.
- Spare Tire Tie-Downs sold separately.
- Add the Cargo Box Net to secure and confine your cargo in the rack.
- Can be installed without a roof or with Sport Roof.

Maverick Sport MAX
715004095



SPARE TIRE RATCHET TIE-DOWNS

- 3-way ratcheting tie-down strap with loop ends.
- Designed to securely hold spare tires on accessories equipped with integrated spare tire attachment points.
- Adjustable to accommodate most common UTV tire sizes.
- Ratchet and junction ring made of durable zinc-plated steel.
- Required for spare tire attachment on Adventure Roof Rack and LinQ Pivoting Rack.

Maverick Trail, Maverick Sport, Maverick Sport MAX
280000606



CARGO BOX NET

- Solid net designed to secure and assure a compact confinement of your Adventure Roof Rack cargo.

Maverick Trail, Maverick Sport, Maverick Sport MAX
715001371





EXPERT CHOICE

LinQ PIVOTING RACK

- LinQ latched rack allows for extra LinQ mounted accessories or the addition of ATV LinQ rack extensions.
- Includes custom tie-down strap for fast spare tire installation or removal (tire not included).
- Gas-cylinder pivot action, locks in the raised position.
- Not compatible with Gear Rail (715003703), Lonestar Racing and DragonFire tire carrier, Lonestar Racing Number Plate, Rear Intrusion Bars and LinQ Cargo Rack.
- Compatible with the All-Terrain Trunk Cover.

Maverick Trail, Maverick Sport, Maverick Sport MAX

715004708



FRONT RACK

- Rugged looking front rack mounts on top of vehicle hood and provides additional protection and cargo capacity.
- Heavy-duty 3/4" (1.9 cm) diameter steel-tube construction.
- 50 lb (22.7 kg) load capacity.
- Inside and outside anti-corrosion coating with durable powder coat finish.
- Flip-up configuration provides easy access to service area.
- Can be installed with or without a front bumper.
- Not compatible with DragonFire Front Exo-Frame.

Maverick Trail, Maverick Sport, Maverick Sport MAX

715004302





EXPERT CHOICE

LinQ RACK EXTENSION

- Made of strong and durable die cast aluminum.
- Helps to keep cargo securely in place.
- Easy and tool-less installation thanks to the LinQ System.

Maverick Trail, Maverick Sport, Maverick Sport MAX
715003771



LinQ CARGO RACK

- Made of durable die cast aluminium and strong aluminium tubing frame.
- Allows the installation of LinQ Trunk Boxes on top, and the addition of more LinQ accessories in cargo box.
- Easy and tool-less installation thanks to the LinQ System.

Maverick Trail, Maverick Sport, Maverick Sport MAX
715003702



SPARE TIRE CARRIER

- Holds spare tire in place.
- Designed for fast tire removal.
- Can hold tires up to 30" in diameter (tire is not included).
- Rear bumper mounted, does not encumber the cargo area.
- Made of heavy-duty 1.5" (3.8 cm) diameter steel tubing.
- Inside and outside anti-corrosion coating with durable powder coat finish.
- The Wheel Jack (715001719) can be attached by using the Spare Tire Ratchet Tie-Downs (280000606).
- Requires Rear Trail Bumper (715007109) or Rear Rancher Bumper (715004304).

Maverick Trail, Maverick Sport, Maverick Sport MAX
715004471



LinQ TOOL HOLDER

- Ultra-versatile tool holder.
- Convenient swivel-latch allows tools to be stored in any orientation.
- Sold in pairs.
- Not compatible inside the cargo box.

Maverick Trail, Maverick Sport, Maverick Sport MAX
715003059





STRONGHOLD GUN BOOT IMPACT[†] BY KOLPIN[†]

- Compact low-profile design with Kolpin Stronghold styling securely holds up to 52" (132 cm) long rifles and shotguns with optics.
- Includes a removable, shock absorbing foam Impact[†] liner.
- Single-handed opening with an attached lid for quick access along with an integrated closure strap.
- For use with the Kolpin Stronghold Auto-Latch Mount System.

Maverick Trail, Maverick Sport, Maverick Sport MAX
705011442



UNIVERSAL SAW PRESS BY KOLPIN

- Specially crafted for transporting your chainsaw securely and safely aboard your side-by-side vehicle.
- Heavy-duty, black powder-coated metal bracket designed to attach any chainsaw model with up to a 20" (51 cm) bar.
- Rubber pads provide cushion and tight fit.
- Hinged design for quick removal.
- Holds saw in vertical position or 45° angle in either direction.
- Requires Gear Rail (715003703).
- Protective sheath included.

Maverick Trail,
Maverick Sport,
Maverick Sport MAX
715001423



STRONGHOLD AUTO-LATCH MOUNT BY KOLPIN

- Auto-latching design provides quick and secure gun boot attachment to your vehicle.
- Bracket is made from rugged high-impact, reinforced nylon and coated steel.
- For use with Stronghold Gun Boot (705011442).
- Requires Gear Rail (715003703).

Maverick Trail, Maverick Sport, Maverick Sport MAX
715003899



GEAR RAIL

- Sturdy gear rail design with C-clamps attached on the roll cage.
- Offers mounting points for the Stronghold Auto-Latch Mount or for the Universal Saw Press by Kolpin.
- Can hold up to two gun boots.
- Not compatible with the Gun Boot 6.0 Impact by Kolpin (715001419).

Maverick Trail,
Maverick Sport,
Maverick Sport MAX
715003703



LIGHTS



BAJA DESIGNS LEDS ARE DEVELOPED BY THE SCIENTISTS OF LIGHTING TO SHINE FARTHER AND SURVIVE BEYOND THE BEATEN PATH - ALL WITH A LIFETIME WARRANTY.

10" (25 CM) BAJA DESIGNS ONX6 LED LIGHT BAR

- 108W light bar producing 12,460 lumens.
- Equipped with 6 Cree XM-L2 LEDs.
- Driving/Combo light pattern for smooth blend of light for both near field applications and distance.
- Dual intensity (high/low) settings plus strobe mode.
- Can be installed on Can-Am Front Bumpers, Sport Roof and Bimini Roof.
- Requires Baja Designs Light Power Cable.

Maverick Trail, Maverick Sport, Maverick Sport MAX

710006819



12,460 LUMENS

10" (25 cm) OnX6 Combo

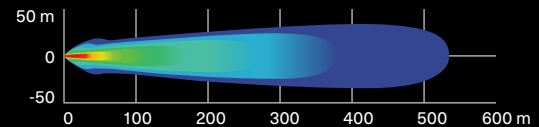

BAJA DESIGNS SQUADRON SPORT LED LIGHTS

- 26W per spot producing 3,150 lumens.
- Equipped with 4 Cree XP-G2 LEDs per spot.
- Can be installed on Can-Am Front Bumpers, sport roof and Bimini Roof.
- Requires Baja Designs Light Power Cable.
- Wide cornering light pattern designed specifically for cornering, dust and/or fog conditions.
- Sold in pairs.
- Dimensions: 3" x 3" (7.6 cm x 7.6 cm).

Maverick Trail, Maverick Sport, Maverick Sport MAX

710006820



3,150 LUMENS

Squadron Sport Wide Cornering

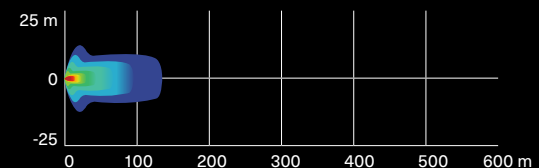

BAJA DESIGNS XL SPORT LED LIGHTS

- 26W per spot producing 3,150 lumens.
- Equipped with 4 Cree XP-G2 LEDs per spot.
- High Speed Spot features a longer and narrower beam focus for illumination farther down.
- Can be installed on Can-Am Front Bumpers, Sport Roof and Bimini Roof.
- Requires Baja Designs Light Power Cable.
- Dimensions: 4.5" x 4.5" (11.4 cm x 11.4 cm).
- Sold in pairs.

Maverick Trail, Maverick Sport, Maverick Sport MAX

710006821



3,150 LUMENS

XL Sport Spot

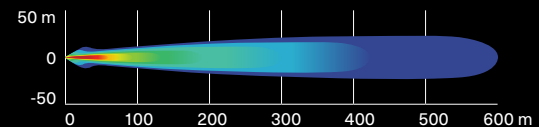

BAJA DESIGNS XL80 LED LIGHTS

- 80W per spot producing 9,500 lumens.
- Equipped with 4 Cree XHP50 LEDs per spot.
- Dual intensity (high/low) settings.
- Driving/Combo light pattern for smooth blend of light for both nearfield applications and distance.
- Can be installed on Can-Am Front Bumpers, Sport Roof and Bimini Roof.
- Requires Baja Designs Light Power Cable.
- Dimensions: 4.5" x 4.5" (11.4 cm x 11.4 cm).
- Sold in pairs.

Maverick Trail, Maverick Sport, Maverick Sport MAX

710005041



9,500 LUMENS

XL80 Combo

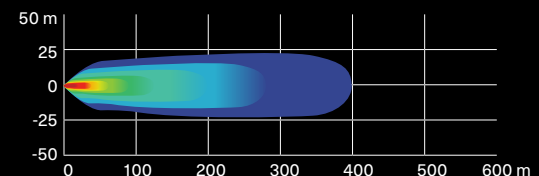

39" [99 CM] DOUBLE STACKED LED LIGHT BAR [270 WATTS]

- Equipped with 54 5W Cree LEDs.
- 24,300 lumens.
- Not compatible with Full Windshield, Flip Windshield and Can-Am Intrusion Bar.
- See table for mounting location and installation requirements.

Maverick Trail, Maverick Sport, Maverick Sport MAX
715004007



24,300 LUMENS

Lights up to more than 2900 ft (900 m) in front of the vehicle and around 115 ft (35 m) wide on each side.

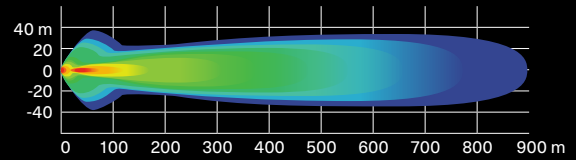

15" [38 CM] DOUBLE STACKED LED LIGHT BAR [90 WATTS]

- Equipped with 18 5W Cree LEDs.
- 8,400 lumens.
- Rugged and waterproof.
- EC compliant.
- See table for installation location and requirements.

Maverick Trail, Maverick Sport, Maverick Sport MAX
715002934



8,400 LUMENS

Lights up to more than 1900 ft (580 m) in front of the vehicle and around 65 ft (20 m) wide on each side.

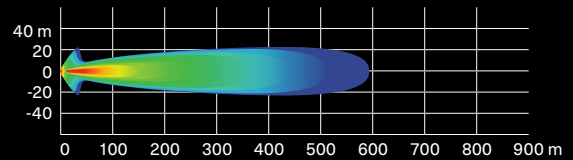

10" [25 CM] DOUBLE STACKED LED LIGHT BAR [60 WATTS]

- Equipped with 12 5W Cree LEDs.
- 5,400 lumens.
- Rugged and waterproof.
- Packs a big punch for its size.
- EC compliant.
- See table for installation location and requirements.

Maverick Trail, Maverick Sport, Maverick Sport MAX
715002933



5,400 LUMENS

Lights up to more than 1500 ft (460 m) in front of the vehicle and around 65 ft (20 m) wide on each side.

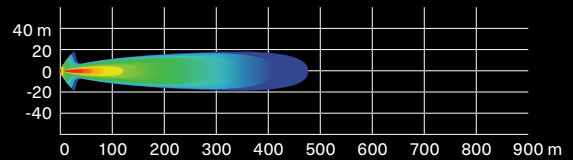

4" [10 CM] ROUND LED LIGHTS [2 X 25 WATTS]

- 25W LED spotlights.
- 1,800 lumens.
- Rugged and waterproof.
- Includes basic wiring and switch.
- Can-Am branded grill.
- Sold in pairs.
- Not EC compliant.
- See table for installation location and requirements.

Maverick Trail, Maverick Sport, Maverick Sport MAX
715002935



1,800 LUMENS

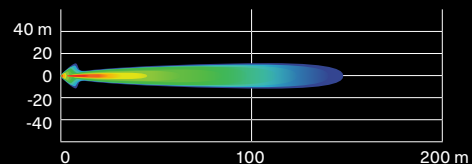

BUILD YOUR LIGHTING SYSTEM. Refer to p. 48



FLOOD THE BED WITH A STRONG LIGHT WHILE GRABBING CARGO, REVERSING, AND WORKING.

3.5" (9 CM) LED FLOOD LIGHTS

3.5" (9 CM) LED LIGHTS (2 X 14W)

- 14W LED lights producing 1,260 lumens each.
- Equipped with 6 high power LEDs in a heavy-duty die cast aluminum housing.
- Features 2 attachment points – if one attachment point fails due to a collision, rotate to the next channel point and re-mount the light.
- Sold in pairs.
- EC compliant.

Maverick Trail, Maverick Sport, Maverick Sport MAX

LED DRIVING LIGHTS

- Spot lens for a narrow and long light beam spread, ideal when driving at higher speeds.

715003666

LED FLOOD LIGHTS

- Flood lens for a wide light beam spread, ideal for working applications like plowing or for cornering, dusty or foggy riding conditions.

715003665



1,260 LUMENS

LED Driving Lights

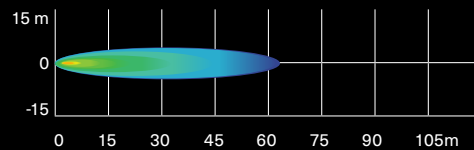

LED Flood Lights

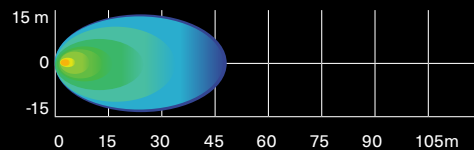

REAR LIGHT POWER CABLE

(Not illustrated)

- Power cable that allows you to install rear cargo lights on your vehicle.
- Use in conjunction with the 3.5" (9 cm) LED Flood Lights (2 x 14W) (sold separately).
- This set-up will illuminate your rear cargo area and surroundings.
- Sport Roof and Overhead Switch Panel (715003669) required.

Maverick Trail, Maverick Sport, Maverick Sport MAX

715004910

BUILD YOUR LIGHTING SYSTEM. Refer to p. 48



BUILD YOUR LIGHTING SYSTEM IN 3 EASY STEPS.

1 CHOOSE YOUR MOUNT POINT	2 CHOOSE YOUR LIGHTS								
	BAJA DESIGNS LIGHTS				CAN-AM LIGHTS				
	10" (25 cm) LED light bar	XL Sport LED lights (sold in pairs)	Squadron Sport LED lights (sold in pairs)	XL80 LED lights (sold in pairs)	10" double stacked LED bar	15" double stacked LED bar	39" double stacked LED bar	4" round LED lights (sold in pairs)	3.5" spot or flood LED lights (sold in pairs)
	Consult P.50 for more information on these lights.				Consult P.48 for more information on these lights.				
Trail Bumper & Rancher Bumper	NA	710006821 PLUS 715002884 (Power Cable)	710006820 PLUS 715002884 (Power Cable)	710005041 PLUS 715003729 (Power Cable)	715002933 PLUS 715003670 (Mounting Kit)	NA	NA	715002935 (4" Round), 715003665 (3.5" Flood) or 715003666 (3.5" Spot) PLUS 715003670 (Mounting Kit)	
DragonFire Racing Front Bumper	NA	NA	NA	NA	715002933 PLUS 715003670 (Mounting Kit)	NA	NA	715002935 (4" Round), 715003665 (3.5" Flood) or 715003666 (3.5" Spot) PLUS 715003670 (Mounting Kit)	
Lonestar Racing Front Bumper	NA	NA	NA	NA	NA	NA	NA	NA	NA
Sport Roof & Bimini Roof	710006819 PLUS 715007049 (Power Cable) *Optional: Overhead Switch Panel 715003669	710006821 PLUS 715002884 (Power Cable) *Optional: Overhead Switch Panel 715003669	710006820 PLUS 715002884 (Power Cable) *Optional: Overhead Switch Panel 715003669	710005041 PLUS 715007049 (Power Cable) *Optional: Overhead Switch Panel 715003669	715002933 PLUS 715003669 (Overhead Switch Panel)	715002934 PLUS 715003669 (Overhead Switch Panel)	715004007 PLUS 715005822 (Mounting Kit) *Optional: Overhead Switch Panel 715003669	715002935 (4" Round), 715003665 (3.5" Flood) or 715003666 (3.5" Spot) PLUS 715003669 (Overhead Switch Panel)	
Top Roll Cage & DragonFire Aluminum Roof	NA	NA	NA	NA	NA	NA	715004007 PLUS 715005822 (Mounting Kit)	NA	NA
Lonestar Racing Aluminum Roof	NA	NA	NA	NA	NA	NA	715004007 PLUS 715004877 (Light Mounts) & 715005822 (Mounting Kit)	NA	NA
Sport Roof Back position	NA	NA	NA	NA	NA	NA	NA	NA	715003665 or 715003666 PLUS 715003669 PLUS 715004910

3 ORDER

ORDER ALL PART NUMBERS IN INTERSECTING BOX

*Note: when installing more than one light kit, additional light power cable or mounting kit is required.

*All lights are intended for Off-Road use only.



CAN-AM LED SIGNATURE LIGHTS

CAN-AM LED SIGNATURE LIGHTS

- Add style with a more aggressive look.
- Use bright and energy efficient LEDs.
- Do not give additional lighting for driving.

Maverick Trail, Maverick Sport, Maverick Sport MAX
715003673

LED HEADLIGHT KIT

- The headlights in this upgrade kit draw a maximum of 40W (2 x 20W) of power while providing brighter light output.
- Lower power consumption and longer lasting than standard halogen bulbs.

Maverick Trail, Maverick Sport, Maverick Sport MAX
715003667

ROOF TAIL LIGHT

- Roof mounted tail and brake light increases your visibility for following vehicles.
- Uses bright and energy efficient LEDs.
- Sport Roof (715006218/Max: 715004704) is required for installation.

Maverick Trail, Maverick Sport, Maverick Sport MAX
715003668



LONESTAR RACING MOUNTS FOR 39" [99 CM] DOUBLE STACKED LED LIGHT BAR

- Low profile mounts allowing for the installation of the 39" (99 cm) Double Stacked LED Light Bar on the Lonestar Racing Aluminum Roof (sold separately).

Maverick Trail, Maverick Sport, Maverick Sport MAX
715004877



DOME LIGHT

- LED array integrates perfectly with vehicle.
- Wiring included.
- Can be installed on cage, sport roof or All-Terrain Trunk Cover.

Maverick Trail, Maverick Sport, Maverick Sport MAX
715002455



MOUNTING KIT FOR 39" [99 CM] LED LIGHT BAR

- (Not illustrated)
- Required for installation of the 39" (99cm) Double Stacked LED Light Bar.
- Includes wiring and support bracket.

Maverick Trail, Maverick Sport, Maverick Sport MAX
715005822

LIGHT POWER CABLE

- (Not illustrated)
- Power cable for installation of compatible Can-Am light kits on Front Bumpers.

Maverick Trail, Maverick Sport, Maverick Sport Max
715003670

BAJA DESIGNS LIGHT POWER CABLE

- (Not illustrated)
- Required for installation of Baja Designs LED lights onto roof or bumper.

Maverick Trail, Maverick Sport, Maverick Sport MAX
10" (25 cm) Baja Designs OnX6 LED Bars and Baja Designs XL80 LED Lights
715007049

Baja Designs XL Sport LED Lights and Baja Designs Squadron Sport LED Lights
715002884

AUDIO & COMMUNICATION SYSTEMS

YOUR RIDE, YOUR TRAIL, YOUR TUNES: PUMP UP THE VOLUME WHEREVER YOU MAY ROAM WITH THESE RUGGEDLY-ENGINEERED AUDIO ACCESSORIES!



EXPERT CHOICE

COMPLETE WET SOUNDS AUDIO SYSTEM

- Orchestrated for outstanding sound quality and the playlists of champions.
- Built-in 200W amplifier with D-Bass Tech for improved low end bass response.
- Built-in Bluetooth connectivity with source control.
- Aux input allows for use with non-Bluetooth devices.
- Turns itself off after 10 minutes of inactivity to save battery power.
- Designed to be Can-Am-tough in the most demanding riding conditions.
- Includes 4.5" (11.4 cm) front and 6.5" (16.5 cm) rear-roll-cage mounted stereo speakers and console integrated backlit control panel.

Maverick Trail, Maverick Sport, Maverick Sport MAX
715003672



WET SOUNDS STEALTH 6 ULTRA HD CAN-AM EDITION SOUND BAR

- Built-in 200W amplifier with D-Bass Tech for improved low end bass response.
- Full range speaker array plus additional titanium dome tweeters for dynamic output and performance.
- HD High Output drivers with new composite high-stiffness frames.
- Built-in Bluetooth connectivity with source control.
- RF wireless remote for full control from steering wheel cradle.
- Aux input allows for use with non-Bluetooth devices.
- Turns itself off after 10 minutes of inactivity to save battery power.
- Backlit control panel.
- 2V line-output allows for hooking up another sound bar or adding an external amplifier and speakers.
- IP67 rated for better protection against the elements.
- Powder coat finish for extra durability and resistance to the elements.
- Requires Sound Bar Mount kit (715004745).

Maverick Trail, Maverick Sport, Maverick Sport MAX
710006028



SOUND BAR MOUNT KIT

(Not illustrated)

- Required Mount kit for the Wet Sounds Stealth 6 Ultra HD Can-Am Edition Sound Bar (710006028).

Maverick Trail, Maverick Sport, Maverick Sport MAX
715004745



EXPERT CHOICE

ELECTRONIC DEVICE HOLDER

- A great in-ride entertainment system platform.
- Robust injected-polypropylene construction allows for right fit and easy installation.
- Adjustable unit safely holds most tablets and smartphones measuring between 5.1" (13 cm) and 10" (25.4 cm) (with protective case).
- Complements perfectly the Wet Sounds audio systems or Rugged Radios Intercom System to play music with your device.
- Allows the installation of Garmin Montana 680T GPS.
- Integrated storage (2.5 Gal (9.5 L) capacity with access to the dash 12V outlet for device charging.
- Integrated mounting location for RAM mounts.
- Not compatible with Defrost, Heat and Ventilation system (715003678).

Maverick Trail, Maverick Sport, Maverick Sport MAX
715005212



RUGGED RADIOS CAR-TO-CAR SYSTEM

- Perfect for communicating with friends and family on group rides.
- Push-to-talk button conveniently mounted on the steering wheel.
- Includes radio mounting bracket, helmet speaker, mic kit and base charger.
- May be synched with the Rugged Radios Intercom System (715002891).
- 2-4 mile range.

This kit includes:

- RH-5R Rugged Radios 5-Watt Dual Band Handheld Radio
- Helmet Speaker/Mic kit
- Push-to-talk buttons
- Mounting bracket
- Base station charger

Maverick Trail, Maverick Sport, Maverick Sport MAX
715003440



RUGGED RADIOS INTERCOM SYSTEM

- Specifically designed to facilitate clear in-vehicle communication between driver and passenger(s).
- Expandable to 4 people.
- Includes music port for enjoying your favorite tunes.
- Seamless integration with in-dash switch panel.
- May be synched with the Rugged Radios Car-To-Car System (715003440).

Maverick Trail, Maverick Sport, Maverick Sport MAX
715002891



RUGGED RADIOS HELMET HEADSET KIT FOR REAR PASSENGERS

- Additional 12' (3.7 m) cables and Helmet Speaker/Mic kits to upgrade your 2-person intercom system into a 4-person system.

With Rugged Radios Intercom System
715004380



ELECTRICAL & ELECTRONIC

OUR HEATED ACCESSORIES WORK HARD TO KEEP YOU COMFORTABLE IN THE COLDEST WEATHER.



FLICK THE SWITCH

Can-Am heated accessories are seamlessly integrated with your Maverick Sport or Maverick Trail and include an in-dash switch for easy On/Off and temperature control.



LET THERE BE HEAT

The defrost, heat and ventilation system offers three (3) ventilation speeds, dashboard temperature controls, and five (5) vents positioned for maximum defrost and complete interior comfort.

**EXPERT
CHOICE****HEATED STEERING WHEEL**

- Ruggedly-constructed steering wheel designed to withstand cold conditions while channeling heat directly to your hands.
- Perfect for making hand mobility and grip readily available, e.g., hunting, manual farming.
- Replaces stock steering wheel.
- This kit includes the heated steering and in-dash switch.
- Heated Accessories Wiring Harness (710005757) is required.
- Draws a maximum of 45W and 3.2A at 13.5V.

**Maverick Trail,
Maverick Sport,
Maverick Sport MAX**
715004283

**DEFROST, HEAT AND VENTILATION SYSTEM**

- Best integrated system on the market with 3-ventilation speed and in-dash adjustable temperature.
- Adjustable/directional vents.
- 5 vents specially positioned for better windshield defrosting and passenger comfort.
- Automotive-style heater core and fan for best heating performance.
- Smart-Lok™ equipped vehicles require adaptor kit (715007241).

**Maverick Trail,
Maverick Sport,
Maverick Sport MAX**
715003678

**HEATED GRAB BAR COVER**

- Made tough to hold up to the stresses of rough riding, this heated cover will keep your passenger's hands warm and securely gripped during long cold outings.
- Easy to install and remove.
- This kit includes the heated grab bar cover and in-dash switch.
- Heated Accessories Wiring Harness (710005757) is required.
- Draws a maximum of 25W and 1.8A at 13.5V.

Maverick Trail, Maverick Sport, Maverick Sport MAX
715004500

**HEATED SEAT COVER**

- Made of rugged vinyl, this heated seat cover delivers chill free riding comfort.
- Ergonomically designed to fit snugly over the seat, it is also easy to install and remove.
- High/Low temperature settings allow you to control the desired degree of warmth.
- This kit includes the heated seat cover and in-dash switch.
- Heated Accessories Wiring Harness (710005757) is required for front seats installation and harness (715006004) is required for rear seats installation.
- Draws a maximum of 25W and 1.8A at 13.5V.

**Maverick Trail,
Maverick Sport,
Maverick Sport MAX**
715004501

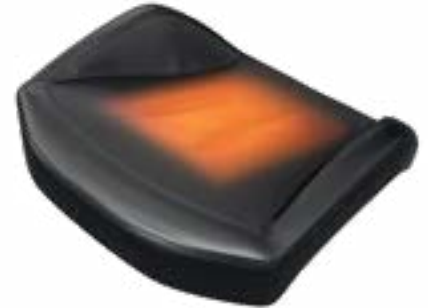
**HEATED SEAT**

- 30W seat heater delivers chill-free riding comfort.
- Hi/Low temperature settings allow you to control the desired degree of warmth.
- This kit includes one carbon fiber seat heater, foam sheet and in-dash switch.
- Installs directly in the original seat cushion.
- Heated Accessories Wiring Harness (710005757) is required.
- Power Cable (715006004) is required for installation on rear seat of MAX models.

**Maverick Trail,
Maverick Sport,
Maverick Sport MAX**
715006112

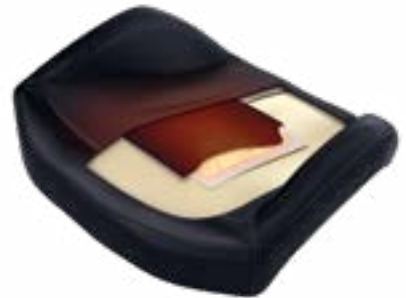
**HEATED VISOR OUTLET**

- Strategically positioned on vehicle to maintain your agility.
- Optional visor outlet that delivers fog-free riding.
- Quick and easy installation.
- Sold individually.
- Heated Visor not included.

**Maverick Trail, Maverick Sport,
Maverick Sport MAX**
715001246

**HEATED SEAT HARNESS FOR MAX MODEL**

- (Not illustrated)
- For rear installed seat heater on Max models.

Maverick Sport MAX
715006004

POWER CABLE

- (Not illustrated)
- Brings power from the battery. Required for installation of some electrical accessories.

**Maverick Trail, Maverick Sport,
Maverick Sport MAX**
715003094

HEATED ACCESSORIES WIRING HARNESS

- (Not illustrated)
- Electric harness required to hook up and operate heated accessories.
 - Power up to 4 accessories: 2 hand accessories (grab bar/steering wheel) and 2 seat covers.

**Maverick Trail, Maverick Sport,
Maverick Sport MAX**
710005757

NEW HEATER ADAPTOR KIT FOR SMART-LOK™

- (Not illustrated)
- Adaptor kit to fit heating system on Smart-Lok™ equipped vehicles.

**Maverick Trail, Maverick Sport,
Maverick Sport MAX**
(Equipped with Smart-Lok™)
715007241

ADJUSTABLE LIGHTED WHIP FLAG

- A must for riding the dunes.
- 5W Cree LED.
- 5 colored lenses to allow personalization.
- Glow-through whip, quickly-removable and replaceable pole.
- Increases vehicle's visibility.
- Meets most dune-area requirements.
- Die cast aluminum base, acetal hand nut.
- Includes adjustable mounting brackets and wiring.

Maverick Trail,
Maverick Sport,
Maverick Sport MAX
715005437



DIGITALLY ENCODED SECURITY SYSTEM (D.E.S.S.™) KEYS

- Top-security anti-theft protection for your vehicle.
- Encrypted chip technology restricts access to your vehicle's electronic ignition system.
- One vehicle/One code.
- A vibration/shock-resistant ball-and-socket design that ensures a reliable connection.
- Comes with 3 programmable keys:
 - Work key: limits vehicle speed to 40 kph (25 mph) but does not limit engine torque.
 - Normal key: limits vehicle speed to 70 kph (44 mph) and 50% torque reduction.
 - Performance key: No restrictions.

Maverick Trail, Maverick Sport,
Maverick Sport MAX
715002458



JUMP STARTER

- IPX3 water-resistant and enclosed output ports.
- 4 LED battery indicators for easy read on battery charge level.
- Compact design, will conveniently fit in your backpack, glove box or any other storage compartment.
- 2.4A + 1A/5V USB ports for fast charging of all USB devices.
- Smart cable provides protection against reverse polarity, short circuit, low voltage, high temperature and reverse charging.
- Built-in LED light (3 modes).
- Content: 300CA jump starter, SA858 smart cable clamp, MC-USB to USB charging cable, travel bag, user manual.

715005062



OVERHEAD SWITCH PANEL

- Fully integrated overhead switch panel gives additional switch spots for electrical accessories.
- Required for Can-Am lights installation on the roof and for other top-mounted electrical accessories.
- Optional for Baja Designs lights.
- Requires sport roof or Bimini Roof with Sun Visor for installation.

Maverick Trail, Maverick Sport,
Maverick Sport MAX
715003669



QUICK CONNECT CABLE WITH BATTERY INDICATOR

- Quickly and easily connect and charge different batteries with your charger.
- 3-color LED indicator provides constant battery health indication.
- Sold individually.

715006055



QUICK CONNECT BATTERY CABLE

- Quickly and easily connect and charge different items with your charger.
- Included in the Battery Charger/Maintainer (715005061).
- Sold individually.

715005408





30AH BATTERY HOLDER

- Fixation plate designed to hold the 30ah Battery.
- 30ah Battery (515176151) sold separately.

Maverick Trail, Maverick Sport, Maverick Sport MAX
715004431



DUAL MODE SWITCH

- Switches quickly and conveniently between normal and eco modes.
- Eco mode increases fuel economy.
- In-dash plug-and-play mount.
- Standard on DPS models.

Maverick Trail, Maverick Sport, Maverick Sport MAX
715004736



12V POWER OUTLET

- 12V accessories outlet.
- Easy plug-in harness included.

Maverick Trail, Maverick Sport, Maverick Sport MAX
715003846



USB POWER OUTLET KIT

- Recharges your electronic devices while riding* (smartphone, MP3, heating gear, etc.).
- Dual port USB connectors.
- * The power outlet is not capable of recharging all device types while riding.

Maverick Trail, Maverick Sport, Maverick Sport MAX
219400510



GARMIN MONTANA⁺ 680T GPS

- Rugged and waterproof, the Montana 680T is element-proof.
- 4" dual-orientation, sunlight-readable touchscreen and glove-friendly touchscreen display, to give you vivid colors and high-resolution images.
- 8-megapixel autofocus camera automatically geotags photos.
- Tracks both GPS and GLONASS satellites for improved positioning and typically faster fixes.
- Preloaded TOPO maps, plus 1-year BirdsEye Satellite Imagery subscription.
- 3-axis compass with barometric altimeter.
- Specific GPS cradle included (vehicle mounting kit required).
- Includes a preloaded map for US.

Maverick Trail, Maverick Sport, Maverick Sport MAX
715002830

European Version

- EC compliant.
- Includes preloaded European recreation map.

715003456



CANADIAN MAP FOR GARMIN MONTANA 680T GPS

(Not illustrated)

- Additional and readily-programmable Canadian basemap for Garmin Montana 680T GPS system.
- Requires Garmin Montana 680T GPS (715002830).

Maverick Trail, Maverick Sport, Maverick Sport MAX
710005065

RAM GPS MOUNT

- Allows for GPS integration onto vehicle.
- Standard AMPSS hole pattern for Garmin Cradle.

Maverick Trail, Maverick Sport, Maverick Sport MAX
715003325



WINCHES & HITCHES

WARN† VRX

- Extreme IP68-rated waterproof sealing keeps the elements out.
- Durable all-metal construction.
- Black powder-coated finish and stainless steel fasteners for corrosion resistance.
- Robust clutch design based on 70+ years of WARN 4WD hub lock know-how.
- Load-holding brake for great control.
- Smooth and reliable all-metal three-stage planetary gear train.
- Dash-mounted rocker control and corded remote.
- Limited lifetime warranty (mechanical), 3-year warranty (electrical).
- Pulling strength capability of 4,500 lb (2,041 kg).

WARN VRX 45 WINCH

- 50 ft. of 1/4" (15 m of 6.3 mm) wire steel cable.
- Roller fairlead.
- Winch Electrical Harness (715003777) is required for installation on Base and DPS models.

Maverick Trail, Maverick Sport, Maverick Sport MAX
715006110



CAN-AM HD

- Ergonomic clutch handle.
- Rugged all-steel gears and bushings for more torque and durability.
- Automatic 100% load-holding brake.
- Sealed solenoid for all-weather protection.
- Weather sealed corded remote and dash mounted switch.
- EC compliant.

CAN-AM HD 4500 WINCH

- Pulling strength capability of 4,500 lb (2,041 kg).
- 43 ft. of 15/64" (13.1 m of 6.3 mm) wire steel cable.
- Heavy-duty 4-way roller fairlead.
- Winch Electrical Harness (715003777) is required for installation on Base and DPS models.

Maverick Trail, Maverick Sport,
Maverick Sport MAX
715006416



WARN VRX 45-S WINCH

- 50 ft. of 1/4" (15 m of 6.3 mm) synthetic rope.
- Cast aluminum fairlead.
- Winch Electrical Harness (715003777) is required for installation on Base and DPS models.

Maverick Trail, Maverick Sport, Maverick Sport MAX
715006111



CAN-AM HD 4500-S WINCH

- Pulling strength capability of 4,500 lb (2,041 kg).
- 50 ft. of 1/4" (15.2 m of 6.35 mm) synthetic rope.
- Corrosion-proof aluminum hawse fairlead.
- Winch Electrical Harness (715003777) is required for installation on Base and DPS models.

Maverick Trail, Maverick Sport,
Maverick Sport MAX
715006417



CAN-AM HD HAWSE FAIRLEAD

- A must when upgrading your winch with a synthetic cable, this corrosion-proof aluminum hawse fairlead will prevent the cable from snapping in a corner of a roller fairlead and from wearing prematurely due to the rough surface of the worn roller guide.
- Must be used with synthetic cables only.

Can-Am HD winch
715006426



WARN HAWSE FAIRLEAD

- Double-powder-coated construction.
- Required to use the Synthetic Winch Cable (715001118) on Warn winches.
- To be used with synthetic winch cables only.

With Warn winch
705204567



WIRED REMOTE CONTROL

- This kit allows winch owners to add the hand-held remote to vehicles with a stock winch.
- OEM stock winch and Wired Remote Control are sold separately.
- EC compliant.

Can-Am HD winch
Remote control (710007050) and connection socket are included.
715006504

Warn winch
Harness (710001023) is required to use remote control on a vehicle with a factory installed winch.
710001002



WIRELESS REMOTE CONTROL

- The system is quick and easy to install, thanks to a wiring harness with an integrated antenna and all necessary mounting hardware.
- Allows you to operate your winch from anywhere within a 50' (15.2 m) radius, increasing your recovery options.
- All components are weatherproof.

With Warn winch
715002542



SYNTHETIC WINCH CABLE

- 50' of 7/32" (15.2 m of 5.5 mm) synthetic cable for Warn winch.
- Warn Hawse Fairlead (705204567) is required when upgrading to a synthetic cable to avoid damage and premature wear of the cable.
- 50 ft. of 3/16" (15.2 m of 4.8 mm) synthetic cable for winches.
- Hawse Fairlead (715006426) is required when upgrading to a synthetic cable to avoid damage and premature wear of the cable.

With Warn winch
715001118

With Can-Am HD winch
715006430



X rc/X mr FRONT TOW HOOK

- Offers a solid place to hook onto in case towing is needed.
- Allows you to attach most straps and hooks.
- Made of rugged 1/8" (3 mm) steel plate and 3/8" (11 mm) steel hook tube.
- Standard on Maverick X rc and X mr models.

Maverick Trail, Maverick Sport, Maverick Sport MAX
715005229



SYNTHETIC CABLE EXTENSION

- Lightweight 1/4" (6.3 mm) diameter, easy to handle and won't rattle in cargo box.
- Easily attaches to winch cable to provide additional 50' (15.2 m) of distance.
- 4,500 lb (2,041 kg) single line capacity.

Maverick Trail, Maverick Sport, Maverick Sport MAX
715001120



ROLLER FAIRLEAD

- Suggested when changing the wire rope.
- Heavy-duty replacement fairlead for winches.

With Warn winch
715001119

With Can-Am HD winch
715007082



WIRE ROPE REPLACEMENT

- 55' of 7/32" (16.8 m of 5.5 mm) steel wire rope for Warn winch kit.
- 47 ft. of 1/4" (14.3 m of 6.3 mm) steel wire rope for Warn winch kit.
- 4,500 lb (2,041 kg) pulling strength.

With Warn winch
715001117

With Can-Am HD winch
705014978



FRONT RECEIVER HITCH

- Heavy-duty 1,500 lb (680 kg) towing capacity 2" (5 cm) receiver hitch.
- Perfect for precision towing in small spaces.

Maverick Trail, Maverick Sport, Maverick Sport MAX
715003642



WINCH ELECTRICAL HARNESS

- (Not illustrated)
- Required for winch installation on Base and DPS models.

Maverick Trail, Maverick Sport, Maverick Sport MAX
715003777

FRONT AND REAR HITCH DRAWBAR (T HOMOLOGATED)

- (Not illustrated)
- Hitch Drawbar with 2" (5 cm) hitch ball.
 - Standard equipment on European class T models.
 - Compliant with European T standards.
 - Fits receiver hitches but does not change the vehicle's homologation.

Maverick Trail, Maverick Sport, Maverick Sport MAX
705206264

PERFORMANCE



GRIP LIKE NEVER BEFORE

Can-Am exclusive: Respond to Off-Road conditions like never before with 4WD powered by Smart-Lok™ Technology.

Smart-Lok™ is the most advanced Off-Road differential at your command. It's a fully lockable on-the-fly front differential with electronically-controlled automatic modes that always returns maximum traction in every condition, period.

1 START WITH THE SMART-LOK DIFFERENTIAL

SMART-LOK™ DIFFERENTIAL

- Can-Am-exclusive Smart-Lok™ technology constitutes a true full lockable on-the-fly front differential with electronically-controlled automatic modes.
- Choose your differential settings according to your riding need: "2x4" for rear wheel traction only, "4x4 Front Diff Lock" for a fully locked 4 wheel drive, and "4x4 Smart Modes" that offer preset, intelligent calibrations for your type of riding.
- Using multiple input sources, "Smart Modes" will instantaneously engage locking with the right load at the right moment to procure maximum traction while retaining low-speed maneuverability, allowing for optimal placement and a feeling of confidence.
- The Smart-Lok™ kit comes standard with the Trail Mode.
- Mud, Rock and Trail Activ modes can be added by installing an additional Smart Mode Module (sold separately) to fine-tune your riding environment.
- Requires Performance Half Shafts (2x) and Front Differential kit for installation.

Maverick Trail,
Maverick Sport,
Maverick Sport MAX
705402371



2 GET THE SMART-LOK™ INSTALLATION KIT & PERFORMANCE HALF SHAFT

SMART-LOK™ INSTALLATION KIT

(Not illustrated)
• Includes all necessary hardware and wiring for Smart-Lok™ Differential installation.

Maverick Trail, Maverick Sport,
Maverick Sport MAX
715005330



PERFORMANCE HALF SHAFT

- High-performance design ideal for Off-Road use, with superior wheel power and acceleration for racing, dunes and desert riding.
- Includes CVs, Shaft and Boots with the best suited geometry for your Can-Am vehicle.

Maverick Trail
705402423

Maverick Sport, Maverick Sport MAX
705402281



3 FINE-TUNE YOUR RIDING ENVIRONMENT WITH A SMART MODE MODULE (OPTIONAL)

These modules allow you to add the **Mud**, **Rock** or **Trail Activ** Smart Mode to vehicles equipped with the Smart-Lok™ Differential kit.
• Only one Smart Mode Module can be installed at a time.

POWER THROUGH DEEP MUD

- Designed to deliver superior traction in the deepest mud holes.
- When high engine torque and/or slippage is detected, Smart-Lok™ will fully lock the front end.
- The system will stay locked until throttle release.

MUD SMART MODE MODULE

Models with Smart-Lok™ Differential
715005282

DRIVE WHERE IT ROCKS

- Designed to help cross challenging rocks.
- When high engine torque is detected at low vehicle speed, Smart-Lok™ will progressively lock the front end and will stay engaged until throttle release to prevent wheel slippage and provide optimal traction.
- The progressive engagement allows for easier steering when maneuvering the vehicle.

ROCK SMART MODE MODULE

Models with Smart-Lok™ Differential
715005283

LET THEM TRAIL BEHIND

- Designed for aggressive riding delivering the ultimate cornering precision.
- When high engine torque and/or an increase in vehicle speed is detected, Smart-Lok™ will progressively engage the front end and maintain it engaged until throttle release or vehicle speed reduction.
- The progressive engagement allows for lower smooth steering effort.

TRAIL ACTIV SMART MODE MODULE

Models with Smart-Lok™ Differential
715005284



EXPERT CHOICE

YOSHIMURA SLIP-ON EXHAUST

- Developed in collaboration with Yoshimura.
- Made from 304-grade stainless steel.
- Sporty sound from a lighter than stock muffler.
- USDF/USDA approved spark arrester.
- EPA compliant.
- Not EC compliant.

Maverick Trail, Maverick Sport (except models with 1000R engine)
715003716

**Maverick Sport (with 1000R engine),
Maverick Sport MAX**
715004452



EMERGENCY KIT

- Complete emergency kit provides all essential equipment and supplies to get out of most unfavorable situations powersport enthusiasts may find themselves in.
- Includes jumper cables, air compressor, tire-repair kit, first-aid kit, ratchet tie-down, duct tape, 3,300 lb (1,500 kg) tow strap, zip-ties and cloth rags.

Maverick Trail, Maverick Sport, Maverick Sport MAX
715006102





SNORKEL KIT

- Raises point of engine and CVT air intakes so vehicle can be semi-submersed in water/mud without taking in water to the engine.
- Not compatible with S&B particle separator, LinQ pivoting rack, all rear intrusion bar and all rear panels and windows.
- Standard on Maverick Sport X mr models.
- Not EC compliant.

Maverick Trail, Maverick Sport, Maverick Sport MAX
715003705



FOAM AIR FILTER BY TWIN AIR[®]

- The best choice for the harshest conditions.
- Multiple staged oiled filtering foam for superior dust retaining capacity with high air flow.
- Washable and reusable.

Maverick Trail, Maverick Sport
(except models with 1000R engine)
715003630

Maverick Sport, Maverick Sport Max
(models with 1000R engine)
715002895



SNORKEL PRE-FILTER

- Pre-filter specifically for snorkels.
- Adds extra protection to your engine in harsh riding conditions.
- Helps keep air filter cleaner.
- Filter blocks particles larger than 0.005" (0.13 mm).
- Necessary to maintain vehicle warranty when tracks are installed.

Maverick Trail, Maverick Sport, Maverick Sport MAX
715005598



ENGINE AND CVT PRE-FILTER KIT

(Not illustrated)

- Adds extra protection to your engine and CVT in harsh riding conditions.
- Filter blocks particles larger than 0.005" (0.1 mm).
- Water repellent screen.
- Necessary to maintain the vehicle's warranty when tracks are installed.
- Recommended for winter riding conditions.

Maverick Trail, Maverick Sport, Maverick Sport MAX
715004290

HEAVY-DUTY SPRING KIT

- This set of heavy-duty springs will stiffen your suspension.
- Perfect for reducing vehicle overall sag when shocks are under heavy demand: Heavy loading and hauling or for snow clearing.
- Complete kit of 4 springs.

Maverick Trail
715004961



SHOCK COVERS

(Not illustrated)

- Soft cover for shocks with ventilation holes.
- Eliminate dust and dirt intrusion into the shock cylinder, reducing risk of damage.
- Sold in pairs.

Maverick Sport, Maverick Sport MAX
715002368

APACHE TRACK SYSTEMS



EACH TRACK HAS A SPECIFIC PURPOSE AND IS DESIGNED WITHOUT COMPROMISE FOR WORK AND PLAY. WHETHER IT'S FOR DEEP SNOW RIDING, TRAIL RIDING OR FOR HEAVY LOADS, APACHE TRACKS ARE AKIN TO FLOATING ACROSS THE TERRAIN.

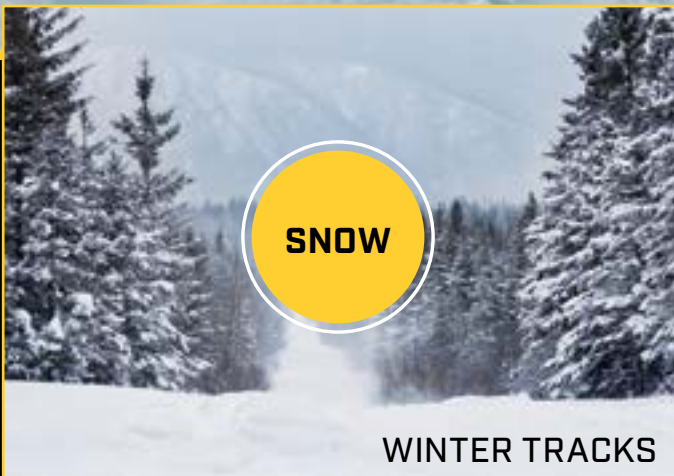

SNOW

WINTER TRACKS

APACHE BACKCOUNTRY

Finally explore winter with no traction limitations and no compromise, thanks to the unmatched performance of Apache Backcountry track kits. Engineered to thrive in the deepest snow – for work or play. Don't let winter stand in the way.



**MIXED
CONDITIONS**

YEAR-ROUND TRACKS

APACHE 360, 360 LT

Adapt your track setup to the conditions you'll be riding in and the purpose of your ride with the Apache 360 LT system: our all-season, all-terrain masterpiece.

WINTER TRACKS

GET THE MOST OUT OF YOUR CAN-AM VEHICLE THIS WINTER FOR ALL YOUR ENDEAVORS.

Explore without compromise. Ride on untouched trails, traveling deep into winter's embrace and you'll know: The same technology behind our world-renowned snowmobiles is at your command. With a larger contact patch, and more aggressive track design, travel beyond what you thought possible with the best snow performance.

COVERED BY A
1-YEAR WARRANTY

APACHE BACKCOUNTRY

Efficient frame and rail design ensures weight is evenly distributed on snow

Added ground clearance of 6.4" (16.2 cm)

Aggressive track design with a 2" (5 cm) lug height for maximum traction



Largest contact patch anywhere: 37% more than the Apache 360 LT

TRACK SYSTEM

- Designed to deliver the best flotation level and deep-snow performance on the market.
- Contact patch is bigger than the Apache 360 LT.
- Provides an impressive average ground clearance increase of 7" (18 cm), keeping the vehicle out of deep snow.
- Aggressive track design with 2" (5 cm) lug height for maximum traction on snow.
- Apache Backcountry Mounting Kit, Track DPS Module (715004707) and engine and CVT pre-filter kit (715004290) are required.
- For winter use only.

APACHE BACKCOUNTRY
Maverick Trail, Maverick Sport,
Maverick Sport MAX
715005247

NEW APACHE BACKCOUNTRY LT
Maverick Sport, Maverick Sport MAX
715005891

MOUNTING KIT

(Not illustrated)

- Required for installation of the Apache Backcountry Track System.
- Track DPS Module and pre-filter not included.
- Not compatible with HMWPE front and rear A-Arm protectors.

APACHE BACKCOUNTRY
Maverick Trail
715004285

APACHE BACKCOUNTRY
Maverick Sport, Maverick
Sport MAX (except X mr,
X rc, X xc models)
715004834

RAIL ICE SCRATCHERS

- Provide additional lubrication in hard and icy conditions.
- Rail mounted, small, light.
- Design expands on coil concept to allow reversing without damage.
- Easily stored when not in use.

Backcountry and
Backcountry LT kits
860201728



IDLER WHEEL KIT

- Reduces drag and rolling resistance.
- Includes 2 wheels, brackets and hardware.
- Add up to 2 kits per rear track.
- Can extend slider life in hardened snow conditions.

Apache Backcountry Track
System, Rear tracks only
860201230 • 141 mm



SLIDERS WITH VESPEL[†] INSERTS

- Use DuPont Vespel inserts for less friction.
- Longer life.
- Can be cut to desired length.
- 8 needed per vehicle.
- Sold individually.

Apache Backcountry and
Apache Backcountry LT Track System
503194815

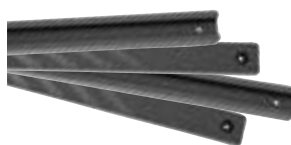

APACHE BACKCOUNTRY LT WHEEL KIT

- Additional wheel kit for Backcountry LT rear tracks.
- Reduces drag and rolling resistance in hard snow conditions or when transporting heavier loads.
- Extends slider life in hard snow conditions.
- Includes two wheels, cross shaft and mounting hardware per kit to service one track corner.
- Up to two kits per rear track can be installed.

Apache Backcountry and
Apache Backcountry LT Track System
715006293



YEAR-ROUND TRACKS

WORK & PLAY YEAR-ROUND THROUGH MUD, SNOW, & ALL TYPES OF TERRAIN.

Rise above terrain, weather, and whole seasons with the Apache 360 LT track kit — the upgrade that takes the Can-Am experience to another level. Designed for superior traction and carrying heavier loads in soft terrain, the 360 LT track kit can be installed on ATV and SSV vehicles and used year-round for exploring and completing tough tasks.

COVERED BY A
2-YEAR WARRANTY

APACHE 360 LT

Added ground clearance of 4.5" (11.4 cm)

 Quick & easy installation



Unique adjustable contact patch system to tackle the toughest year-round conditions



Rubber over molded heavy-duty double bearing wheels and offset wheel spacing reduce friction and vibration while ensuring reliability

Total ground surface area of 2,473.7 in² (14,784 cm²)

APACHE 360 LT TRACK SYSTEM

- Multifunctional tracks designed to support heavy loads and to fit on most Can-Am Off-Road vehicles.
- Extra contact patch adjustment for better performance over rough terrain.
- Average ground clearance increase of 4.5" (11.44 cm).
- 1" (2.5 cm) lugs in the front and 1.25" (3.2 cm) in the back.
- Apache Backcountry Mounting Kit, Track DPS Module (715004707) and engine and CVT pre-filter kit (715004290) are required.

Maverick Trail, Maverick Sport, Maverick Sport MAX
715005103

APACHE 360 LT MOUNTING KIT

- (Not illustrated)
- Required for installation of the Apache 360 LT Track System.
 - DPS Module and pre-filter not included.

Maverick Trail
715004833

Maverick Sport, Maverick Sport MAX (except X mr, X rc, X xc models)
715004755

Required to install the Apache Backcountry and Apache 360 LT Track Systems

SNORKEL PRE-FILTER

- Pre-filter specifically for snorkels.
- Adds extra protection to your engine in harsh riding conditions.
- Helps keep air filter cleaner.
- Filter blocks particles larger than 0.005" (0.13 mm).
- Necessary to maintain vehicle warranty when tracks are installed.

Maverick Trail, Maverick Sport, Maverick Sport MAX
X mr only or equipped with snorkel
715005598



ENGINE AND CVT PRE-FILTER KIT

- (Not illustrated)
- Adds extra protection to your engine and CVT in harsh riding conditions.
 - Filter blocks particles larger than 0.005" (0.1 mm).
 - Water repellent screen.
 - Necessary to maintain the vehicle's warranty when tracks are installed.
 - Recommended for winter riding conditions.

Maverick Trail, Maverick Sport, Maverick Sport MAX (except X mr or when equipped with a snorkel kit)
715004290

TRACK DPS MODULE

- (Not illustrated)
- Innovative DPS module that ensures speedometer accuracy and optimized steering assist, making for perfect track control and riding ease.
 - Required to install the Apache Track Systems.

Maverick Trail, Maverick Sport, Maverick Sport MAX
715004707

PROMOUNT PLOWS

THE PROMOUNT LINEUP WAS CREATED FOR BOTH PROFESSIONAL OPERATORS AND ENTHUSIASTS LOOKING TO TAKE THEIR TOOL KIT TO THE NEXT LEVEL. DESIGNED TO WORK AS EFFICIENTLY AS POSSIBLE, CAN-AM REIMAGINED THE PLOW FROM MOUNT TO BLADE.



MOST EFFICIENT MOUNTING SYSTEM

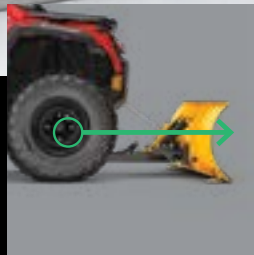

Underbelly mounting plate provides the optimal angle of attack for best push strength.

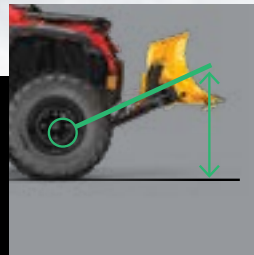

The forward mounted push frame provides industry leading lift height.



Low profile mounting plate has little impact on ground clearance and can be left installed year round.

CONNECTS WITH A CLICK

Attachable in **FOUR EASY STEPS**, the Can-Am ProMount plow system is the fastest, easiest way to start plowing and get the job done – minimal effort for maximum result.

1

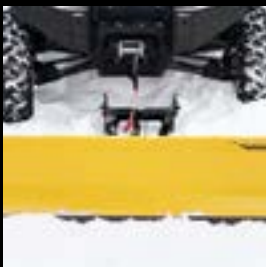

Drive straight toward the plow.

2



Attach the winch cable to the plow using a guiding hook/roller.

3



Lift the plow until it clips onto the mounting plate.

4

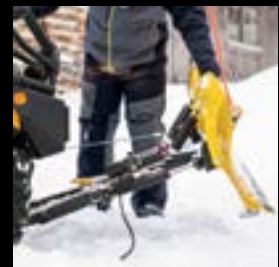

Remove the winch cable from the guide. You're ready to plow.

CAN-AM PROMOUNT STEEL PLOWS

Consult your dealer for the best plow width. Made from 12-gauge steel and designed for efficient plowing, the ProMount steel blades are offered in multiple sizes to fit jobs large or small.

CAN-AM PROMOUNT STEEL PLOW KITS

These kits include:

- Can-Am ProMount Steel Blade
- Push Frame with Quick-Attach System
- Can-Am ProMount Mounting Plate

54" [137 CM] BLADE

Maverick Trail

- 715005200 • Black
- 715005428 • Yellow

60" [152 CM]

Maverick Trail, Maverick Sport, Maverick Sport MAX

- 715005201 • Black
- 715005434 • Yellow

66" [168 CM] BLADE

Maverick Trail, Maverick Sport, Maverick Sport MAX

- 715005427 • Black
- 715005435 • Yellow



CAN-AM PROMOUNT STEEL BLADES

- Blades available individually to create your own kit.
- Compatible with Can-Am ProMount Blade accessories to further enhance plow versatility (some plow accessories are not compatible with 54" plows).

54" [137 CM] BLADE

- Not compatible with ProMount Drift Cutters, Blade Extensions and Edge Markers.
- Clears 50" (127 cm) when plow is fully angled.
- Blade height of 14.75" (37 cm).

Fits ProMount Push Frame

- 715004472 • Black
- 715005316 • Yellow

60" [152 CM] BLADE

- Clears 54" (137 cm) when plow is fully angled.
- Blade height of 17" (43 cm).

Fits ProMount Push Frame

- 715004202 • Black
- 715005317 • Yellow

66" [168 CM] BLADE

- Clears 60" (152 cm) when plow is fully angled.
- Blade height of 17" (43 cm).

Fits ProMount Push Frame

- 715006337 • Black
- 715005318 • Yellow

72" [183 CM] BLADE

- Clears 66" (168 cm) when plow is fully angled.
- Blade height of 17" (43 cm).

Fits ProMount Push Frame

- 715004474 • Black
- 715006021 • Yellow

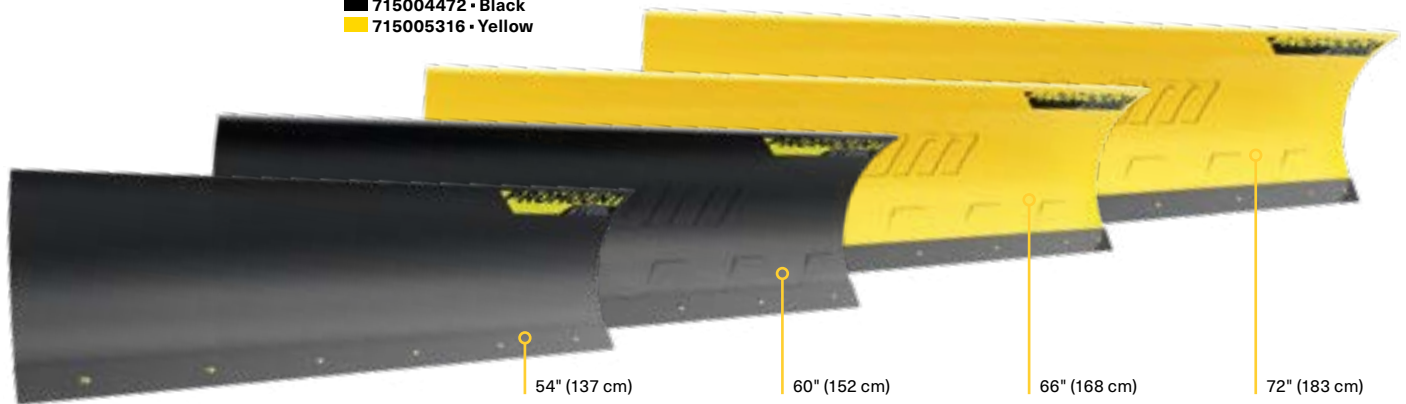

CONSULT YOUR DEALER FOR THE BEST PLOW WIDTH. Made from 12-gauge steel and designed for efficient plowing, the ProMount steel blades are offered in multiple sizes to fit jobs large or small.

CREATE YOUR OWN KIT
by choosing any plow type/length that you'd like for your push frame. **ProMount Push Frames are compatible with all the blades.**

CAN-AM PROMOUNT FLEX2 PLOWS

HMWPE (High Molecular Weight Polyethylene) technology gives Flex2 greater reliability, resistance to impact, and immunity to rust or deformation. Tough on jobs but flexible in the face of obstacles, the Flex2 blade simplifies work.

CAN-AM PROMOUNT FLEX2 PLOW KIT

These kits include:

- Can-Am ProMount Flex2 Blade
- Push Frame with Quick-Attach System
- Can-Am ProMount Mounting Plate

60" (152 CM) BLADE

Maverick Trail, Maverick Sport, Maverick Sport MAX

■ 715005202 • Black



CAN-AM PROMOUNT FLEX2 BLADES

- Blades available individually to create your own kit.
- Compatible with Can-Am ProMount Blade accessories to further enhance plow versatility.

60" (152 CM) BLADE

• Clears 54" (137 cm) when plow is fully angled.

Fits ProMount Push Frame

■ 715004203 • Black

72" (183 CM) BLADE

• Clears 66" (168 cm) when plow is fully angled.

Fits ProMount Push Frame

■ 715004485 • Black

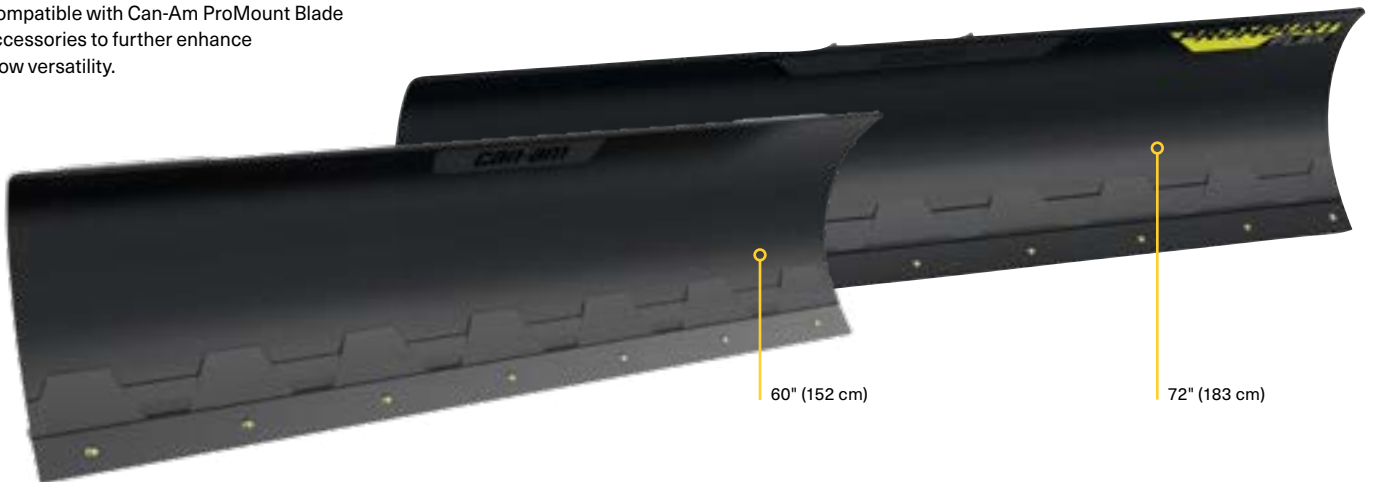

CONSULT YOUR DEALER FOR THE BEST PLOW WIDTH. Made from 12-gauge steel and designed for efficient plowing, the ProMount steel blades are offered in multiple sizes to fit jobs large or small.

CREATE YOUR OWN KIT

by choosing any plow type/length that you'd like for your push frame. **ProMount Push Frames are compatible with all the blades.**



CAN-AM PROMOUNT ANGLE PLOWS

NEW CAN-AM ANGLE BLADES

- Make the job easier with the right tools, clear long alleys and make the task easier by sending the snow further out of the way.
- Wing end of plow measures 25" (63 cm) high and tapers down to 16" (41 cm).
- One-way "winged" state plow designed to throw snow higher.
- Rubber flap designed to keep snow away from the driver.
- Can-Am branded.



**60" [152 CM] STEEL
ONEWAY STATE BLADE**
■ 715007261 · Black

**66" [168 CM] STEEL
ONEWAY STATE BLADE**
■ 715007263 · Black

**72" [183 CM] STEEL
ONEWAY STATE BLADE**
■ 715007264 · Black

CONSULT YOUR DEALER FOR THE BEST PLOW WIDTH.
Made from 12-gauge steel and designed for efficient plowing, the ProMount steel blades are offered in multiple sizes to fit jobs large or small.

CREATE YOUR OWN KIT

by choosing any plow type/length that you'd like for your push frame. **ProMount Push Frames are compatible with all the blades.**

CAN-AM PROMOUNT PLOW ACCESSORIES



① CAN-AM PROMOUNT EDGE MARKERS

- Help locate the edges of your plow.
- Height: 24" (60 cm).
- Sold in pairs.
- Compatible with Can-Am ProMount Steel and Flex2 Blades with or without Blade Extensions (except for the Can-Am ProMount Steel 54" [137 cm] Blades).

Maverick Trail, Maverick Sport, Maverick Sport MAX
715004206

③ CAN-AM PROMOUNT DRIFT CUTTERS

- Help keep snow in the plow.
- Dimensions: 17" x 13" (43.2 cm x 33 cm).
- Sold in pairs.
- Compatible with Can-Am ProMount Steel and Flex2 Blades with or without Blade Extensions (except for the Can-Am ProMount Steel 54" [137 cm] Blades).

Maverick Trail, Maverick Sport, Maverick Sport MAX
715006258

② CAN-AM PROMOUNT PLASTIC WEAR BLADE

- To help prevent scratches on smooth driveways and markable surfaces.

Maverick Trail, Maverick Sport, Maverick Sport MAX

54" (137 cm)	60" (152 cm)	66" (168 cm)	72" (183 cm)
715004480	715004481	715004482	715004483

④ CAN-AM PROMOUNT BLADE EXTENSIONS

- Add 3" (8 cm) each side.
- Compatible with Can-Am ProMount Blades (except for Can-Am ProMount Steel 54" [137 cm] Blade).
- Longer Wear Blade can be installed to further extend the extra length already provided by the extensions.
- Compatible with Can-Am ProMount Steel and Flex2 Blades (except for the Can-Am ProMount Steel 54" [137 cm] Blades).

Maverick Trail, Maverick Sport, Maverick Sport MAX

- 715004205 • Black
- 715005319 • Yellow

CONSULT YOUR DEALER FOR THE BEST PLOW WIDTH.
Made from 12-gauge steel and designed for efficient plowing, the ProMount steel blades are offered in multiple sizes to fit jobs large or small.

CREATE YOUR OWN KIT

by choosing any plow type/length that you'd like for your push frame. **ProMount Push Frames are compatible with all the blades.**

YOUR JOB, YOUR CHOICE

Get a custom solution that truly fits the task at hand – with quality components and no cut corners. The ProMount push frame, mounting plate and blades are a universal system that can be adapted to your specific Can-Am and jobsite.

CAN-AM PROMOUNT PUSH FRAME WITH QUICK-ATTACH SYSTEM

- Heavy-duty steel tubes designed to withstand the roughest use.
- Mid-mount carriage provides ultimate push strength and traction.
- Designed for maximum plow lift height.
- Features a self-aligning quick-attach system, an easy foot release pedal and an ergonomic handle for plow angle adjustment.
- Plow Roller Fairlead and Plow Limit Switch recommended to extend winch cable lifespan.
- Can-Am ProMount Mounting Plate required for installation.
- Blade swivels left or right, 5 positions.
- Large pin designed for easy blade rotation to eliminate dirt and snow buildup at pivot point.

Maverick Trail, Maverick Sport, Maverick Sport MAX

715004339



CAN-AM PROMOUNT PUSH FRAME EXTENSION

- 12" (30 cm) push frame extension.

Maverick Trail, Maverick Sport, Maverick Sport MAX

715006257



CAN-AM PROMOUNT MOUNTING PLATE

- Required to install the Can-Am ProMount Push Frame with Quick-Attach System.
- Mounting plate precision-designed to stay on year round without compromising ground clearance.
- Fits on Maverick Trail or Maverick Sport with or without Can-Am Skid Plates.

Maverick Trail, Maverick Sport

715006360



PLOW ANGLING SYSTEM

- Converts your plow system into an easy-to-control unit from the driver's seat.
- Allows you to have full up/down and left/right plow control at your fingertips by using the supplied joystick.
- Using one hand to control all plow motions will allow you to easily concentrate and manage your plowing tasks.

Compatible with any ProMount Push Frame and Blade

715006022



PLOW ROLLER FAIRLEAD

- Larger diameter lower roller reduces wear on wire rope for plow application.
- Can be used with all ProMount plows.

Maverick Trail, Maverick Sport, Maverick Sport MAX

• Cylindrical Roller Fairlead • Conical Roller Fairlead
715001223 705203753



PLOW LIMIT SWITCH

- (Not illustrated)
- For controlling the cable tension when over raising your plow system.
 - Prevents winch, plow push frame and vehicle damage.
 - Sensor relocated for optimal lift height.

Maverick Trail, Maverick Sport, Maverick Sport MAX
715006259

CONSULT YOUR DEALER FOR THE BEST PLOW WIDTH. Made from 12-gauge steel and designed for efficient plowing, the ProMount steel blades are offered in multiple sizes to fit jobs large or small.

CREATE YOUR OWN KIT

by choosing any plow type/length that you'd like for your push frame. **ProMount Push Frames are compatible with all the blades.**

TRAILERING

TRAILERING COVER

- Weather-resistant trailering cover protects your vehicle during storage and transportation.
- Heavy-duty canvas made of UV-resistant solution-dyed polyester.
- Inner soft liner protects windshield and colored panels from abrasion.
- All high-abrasion areas are reinforced with a double canvas layer.
- Opening for fuel cap.
- Quick and easy installation.
- Designed to perfectly fit your vehicle with or without Can-Am accessories.

Maverick Trail, Maverick Sport
715003706

Maverick Sport MAX
715005281



BOLT-ON[®] RETRACTABLE RATCHETING TIE-DOWNS

- Perfect for transporting your powersport vehicle or securing loads.
- Mounts easily: Bolts on any flat surface (e.g., truck bed or frame).
- 1" x 6' (2.5 cm x 1.8 m) tie-down strap with heavy-duty stitching that delivers a 500 lb (226 kg) working load strength and 1,500 lb (680 kg) break strength.
- Convenient retractable push button automatically slackens, spools and stores away strap, while the ratchet mechanism tightens the strap snugly to secure your vehicle or load into place.
- Rubber ratcheting handle provides firm grip, and the hook is vinyl coated to protect whatever surface it hooks into.
- Sold in pairs.

295100737



NEW RATCHET STRAP KIT

- 1,000 lb (454 kg) safe working load.
- 1.5" x 6' (38 mm x 1.8 m) strap with BRP brands.
- Deluxe ratchet with rubber handle.
- Black-coated clip hooks.
- Two 18" (460 mm) assists straps included.
- Pack of two.

715006227



RATCHET TIE-DOWNS

- 400 lb (181 kg) safe working load.
- 1" x 10' (2.5 cm x 3 m) strap with Sea-Doo, Ski-Doo and Can-Am logos.
- Deluxe ratchet with rubber handle.
- Coated S hooks.
- Pack of 2.

860200447 • Black/Grey



TIRES & RIMS

CARLISLE ACT TIRE

Maverick Trail
Front • 26" x 8" x 12"
705402313

Rear • 26" x 9" x 12"
705402314



MAXXIS BIGHORN 2.0 TIRE

Maverick Sport, Maverick Sport MAX
Front • 27" x 9" x 12"

705402560
705401386 • (C) (E)

Rear • 27" x 11" x 12"

705502938
705501818 • (C) (E)



12" MAVERICK TRAIL DPS / SPORT RIM

- Matching Nuts: 250100184 (Black).
- Matching Cap: 705400928.

Maverick Trail DPS / Maverick Sport

Front • 12" x 6"
Offset = 41mm
705401417

Maverick Sport

Rear • 12" x 7.5"
Offset = 51mm
705501853

Maverick Trail DPS

Rear • 12" x 6"
Offset = 41mm
705401417



MAXXIS LIBERTY TIRE

- Engineered for performance driving and to give you and your side-by-side freedom in a variety of terrains.
- Exceeds DOT test standards.
- 8-ply radial construction.
- Specialized rubber compound for supreme traction and control.
- Excellent tread wear.

Maverick Sport X rc

28" x 10" x 14"
705402401

30" x 10" x 14"
705402143



NEW 14" MAVERICK SPORT X RC / X MR RIM

Maverick Sport X rc / X mr

Front • 14" x 7"
Offset = 41mm
705402338

Maverick Sport X rc

Rear • 14" x 7"
Offset = 41mm
705402338

Maverick Sport X mr

Rear • 14" x 8.5"
Offset = 51mm
705502778



12" MAVERICK TRAIL RIM

- Matching Nuts – 250100042.
- 12" x 6" – Offset = 41 mm

Maverick Trail

705401217



APPAREL

Clothing, helmets, glasses and everything else you need to shift your Can-Am experience into high gear.

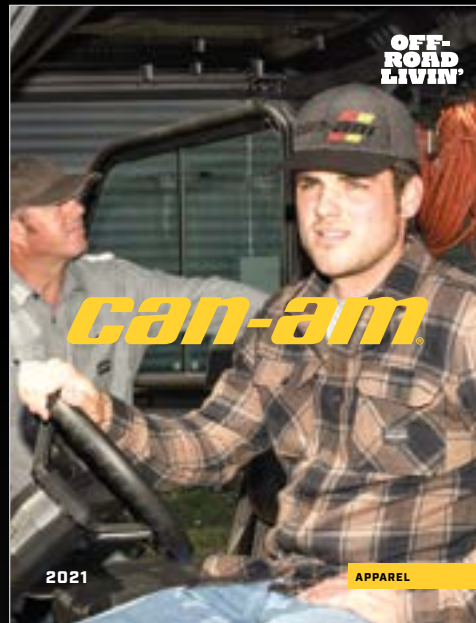

PARTS & MAINTENANCE

Essential items to keep your Can-Am tearing up the tarmac, including oils, filters maintenance products and cleaning products.



EXPLORE AN ENTIRE WORLD OF ADVENTURE WITH ALL OF OUR BRP PRODUCTS. BRP.COM



ski-doo *LYNX* *SEA-DOO* *CAN-AM* *ROTAX* *ALUMACRAFT* *Manitou* *EVINRUDE*



CAN-AMOFFROAD.COM

A BRP BRAND

