

can-am[®]
OUTLANDER
RENEGADE

ACCESSORIES,
RIDING GEAR &
GENUINE PARTS



AUSTRALIAN EDITION

YOUR SEARCH FOR THE PERFECT ACCESSORIES STARTS & ENDS HERE

YOUR GUIDE TO ESSENTIAL FACTORY DEVELOPED AND APPROVED
ACCESSORIES FOR YOUR CAN-AM.



can-am



FIT & COMPATIBILITY

Innovative accessories that are simply better, together. Fit, function and looks—right out of the box—with the peace of mind that the accessories you pick will work perfectly with hundreds of others.



QUALITY & RELIABILITY

Quality and reliability so good, it comes with a 1-year warranty. We stand strong behind our Genuine Can-Am accessories... because we can. Install them yourself or at an authorized dealer and immediately upgrade your off-road vehicle without worry.



STYLE & VISION

Can-Am designers develop vehicles and accessories that look and perform right because they're for riders, period. Everything in this guide is here to benefit your experience—nothing else made the cut.

BRP 1-YEAR LIMITED WARRANTY*

For new Can-Am accessories, genuine parts, and co-branded products sold through BRP¹. Includes items installed by you or an authorized BRP dealer.

*Use other than which the product is designed for will void the product lifetime warranty. ¹Applies only to BRP-made products or co-branded products made by accredited BRP partners (Lonestar Racing for Can-Am, DragonFire for Can-Am, S3 for Can-Am, Beard Seats for Can-Am, Baja Designs for Can-Am, etc.). Purchased at an authorized BRP dealership / distributor or on a BRP-authorized online store. Other exclusions may apply, see complete limited warranty or contact your Can-Am off-road authorized dealer. ²Includes only BRP-approved aftermarket products and products made by currently accredited BRP partners. ^{**}Unless otherwise stipulated or required by law. This limited warranty does not apply to factory installed accessories. This limited warranty does not apply on Evinrude parts and accessories. This limited warranty is effective as of March 1st, 2016.

can-am

OUTLANDER RENEGADE

CONTENTS



HEAVY-DUTY PROTECTION

Ranch and work-ready bumper.

P.34

4 ACCESSORIES

4 Built Inspirations

8 Compatibility Guide

9 LinQ: Easy On
Easy Off Cargo

17 Cargo & Storage

20 Windshields

23 Handlebars & Mirrors

24 Seat Kits



CREATE YOUR OWN WINDSHILED

Modular windscreen protection
options for any rider preference.

P.20

CAN-AMOFFROAD.COM



PROMOUNT — PLOWS

THE POWER TO PUSH FORWARD

Designed to work as efficiently as possible,
Can-Am reimaged the plow from frame to blade.

P.54



APACHE TRACK SYSTEMS

TERRAIN IS NO LONGER THE LIMIT

Get the most out of your Can-Am vehicle
this winter for all your endeavors.

P.49

25 Racks & Holders	49 Apache™ Track Systems	69 Dust Masks /
28 Skid Plates	54 Promount Plows	Communication Systems
32 Bumpers & Guards	59 Tires	70 Goggles / Gloves / Junior
37 Lights & Electrical	60 Rims	71 Bags / Sizing Chart
41 Winches	62 RIDING GEAR	72 PARTS & MAINTENANCE
43 Hitches	66 Can-Am Sportswear	72 Genuine Can-Am Parts
44 Performance	67 Mud Gear	78 XPS Oils & Maintenance
48 Covers, Decals & Add-Ons	68 Helmets	



LINQ SYSTEM™

NO MORE BUNGEEES & ROPES

P.9



Look for this logo throughout the catalogue for Expert recommendations on innovative, must-have, enthusiast-ready parts and accessories that will help you customize your perfect off-road machine.

ENGINE OIL CHANGE KIT

Want to save time and money? Use the ultra-convenient "all-in-one" DIY Engine Oil Change Kit.

P.78



HARD WORK

TAKE ON THE TOUGH TASKS
WITH UTILITY UPGRADES
THAT WORK SEAMLESSLY
AND TIRELESSLY WITH YOU
& YOUR OUTLANDER



OUTLANDER

TAKE YOUR PICK:
Expertly-chosen **STARTER**,
ADVANCE, and **PEAK**
utility packages to take
your Can-Am build to
another level. Or simply
mix and match and create
your own package.

STARTER	715001215	LinQ Heavy-Duty Basket	P.15	
	715001914	8" (20 cm) Rack Extension	P.26	
	715006108	Warn VRX 35 Winch	P.41	
	+			
ADVANCE	715001909	Fender Flares	P.36	
	715003461	Rancher Front Bumper	P.34	
	715003462	Rancher Rear Bumper	P.34	
	715003459	Body Side Protector	P.35	
	+			
PEAK	715001945	Multi-Fit Holder	P.27	
	710005423	Ram LED Spotlight	P.39	
	715005186	Rear Hitch Receiver	P.43	
	715000972	Front & Rear Hitch Drawbar	P.43	

*Note that price does not include installation requirements
and that part numbers may vary depending on vehicle model.



YOU CAN FINANCE THE PURCHASE OF ACCESSORIES

with the purchase and financing of your Outlander. Ask your dealer for all the details.

TRAIL

GO FARTHER WITH
PROVEN TRAIL
ACCESSORIES FOR
ALL-DAY COMFORT
& RELIABILITY



OUTLANDER MAX

TAKE YOUR PICK:
Expertly-chosen **STARTER**,
ADVANCE, and **PEAK**
trail packages to take
your Can-Am build to
another level. Or simply
mix and match and create
your own package.

Package	Part Number	Description	Price
STARTER	715001749	LinQ Trunk Box Outlander Max	P.13
	715006119	LinQ Trunk Box Pannel	P.13
	715001232	Deluxe Fairing	P.21
	715001211	High Windshield for Deluxe Fairing	P.21
	715004837	XT Front Bumper	P.33
	715004920	XT Rear Bumper	P.33
ADVANCE	+		
	715001286	Extreme Front Bumper	P.35
	715002353	Deluxe Mirror Kit	P.21
	715003115	Auxiliary Windshield Lights	P.39
	715003250	Heated Hand Grips & Throttle Combo	P.37
715001926	Heated Passenger Grips & Visor Outlet	P.37	
PEAK	+		
	715004284	Baja Design High Beam Kit	P.39
	715003942	Driver Backrest	P.24
	715004807	HMWPE Skid Plate	P.28

*Note that price does not include installation requirements
and that part numbers may vary depending on vehicle model.



YOU CAN FINANCE THE PURCHASE OF ACCESSORIES

with the purchase and financing of your Outlander MAX. Ask your dealer for all the details.

WINTER

FINALLY ENJOY WINTER WITH COLD-WEATHER ESSENTIALS: THE CAN-AM APACHE TRACK SYSTEM & PROMOUNT PLOW KIT



OUTLANDER MAX

TAKE YOUR PICK:

Expertly-chosen **STARTER** and **ADVANCE** packages are the best way to quickly add cold-weather upgrades—plus plow and tracks for even more winter use. Or mix and match to create your perfect snow-ready Outlander.

STARTER	715004282	LinQ Low Profile Basket	P.15	
	715003023	Extra-High Windshield Kit	P.22	
	715004815	Heated Grips & Thumb Throttle Combo	P.37	
	715001246	Heated Visor Outlet	P.37	
	+			
ADVANCE	715001926	Heated Passenger Grips & Visor Outlet	P.37	
	715004301	LinQ Tool Box	P.11	
	715005111	Fender Flare Extensions	P.36	
	715004293	2" (5 cm) Square LED Lights	P.39	
TRACKS	715005103	Apache 360LT Track System	P.51	
	715004795	Apache 360LT Mounting Kit	P.53	
	715003063	Apache 360 LT Adaptor	P.53	
PLOW	715006109	Warn VRX 35-S Winch	P.41	
	715005202	Can-Am ProMount Flex2 60" (152 cm) Kit	P.56	
	715004204	Can-Am ProMount Push Frame Extension	P.57	
	715004207	Can-Am Promount Drift Cutters	P.58	
	715004206	Can-Am Promount Edge Markers	P.58	

*Note that price does not include installation requirements and that part numbers may vary depending on vehicle model.



YOU CAN FINANCE THE PURCHASE OF ACCESSORIES

with the purchase and financing of your Outlander MAX. Ask your dealer for all the details.

HUNTING

ADAPT QUICKLY FOR THE HUNT BY OUTFITTING THE OUTLANDER TO YOUR EXACT NEEDS



OUTLANDER

For the international market, the Squadron Green color is only available on the Outlander 570 PRO.

TAKE YOUR PICK: Expertly-chosen **STARTER**, **ADVANCE**, and **PEAK** hunting packages to take your Can-Am build to another level. Or simply mix and match and create your own package.

STARTER	715003248	LinQ Premium Storage Bag by Ogio	P.15
	715003021	Low Windshield kit	P.22
	715001419	Gun Boot 6.0 Impact by Kolpin	P.27
	715001918	Gun Boot Rack	P.27
	+		
ADVANCE	715004282	LinQ Low Profile Basket	P.15
	715001910	XT Front Bumper	P.33
	715001911	XT Rear Bumper	P.33
	715003614	Body Side Protector	P.35
	715004279	Extreme Front Bumper	P.35
	715001909	Fender Flares	P.36
	+		
PEAK	715004199	Aluminum Skid Plate	P.29
	715003250	Heated Grips & Thumb Throttle Combo	P.37
	710005423	RAM LED Spotlight	P.39
	715006415	Can-Am HD 3500 winch	P.41

*Note that price does not include installation requirements and that part numbers may vary depending on vehicle model.



YOU CAN FINANCE THE PURCHASE OF ACCESSORIES

with the purchase and financing of your Outlander. Ask your dealer for all the details.

ATV ACCESSORY COMPATIBILITY GUIDE

We've made things super simple.

- Check your model year
- Choose engine and model
- Learn your **PLATFORM CODE**

This **PLATFORM CODE** will let you know at a glance if the accessory is compatible with your vehicle.

EXAMPLE

CARGO BAG

- Rugged all-purpose cargo bag with rain cover for additional protection against the elements.
- LinQ Luggage Rack (715001734) is required for G2S.

G2, G2L, G2S

280000539

For G1 accessories, refer to your local dealer.

Model Year	Model	Engine Configuration	Platform Code
2013	Outlander	400	G1
	Outlander	500, 650, 800, 1000	G2
	Outlander MAX	400	G1
	Outlander MAX	500, 650, 800	G2
	Renegade	500, 800, 1000	G2S
2014	Outlander	400	G1
	Outlander	500, 650, 800, 1000	G2
	Outlander MAX	400	G1
	Outlander MAX	500, 650, 800, 1000	G2
	Renegade	500, 800, 1000	G2S
2015	Outlander L	450, 500	G2L
	Outlander	500, 650, 800, 1000	G2
	Outlander L MAX	450, 500	G2L
	Outlander MAX	500, 650, 800, 1000	G2
	6x6	650, 1000	G2
	Renegade	500, 800, 1000	G2S
2016	Outlander L	450, 570	G2L
	Outlander	570, 650, 850, 1000	G2
	Outlander L MAX	450, 570	G2L
	Outlander MAX	570, 650, 850, 1000	G2
	6x6	650, 1000	G2
Renegade	570, 850, 1000	G2S	
2017	Outlander	450, 570	G2L
	Outlander	650, 850, 1000	G2
	Outlander MAX	450, 570	G2L
	Outlander MAX	650, 850, 1000	G2
	6x6	650, 1000	G2
2018	Outlander	450, 570	G2L
	Outlander	650, 850, 1000	G2
	Outlander MAX	450, 570	G2L
	Outlander MAX	650, 850, 1000	G2
	6x6	650, 1000	G2
Renegade	570, 850, 1000	G2S	
2019	Outlander	450, 570	G2L
	Outlander	650, 850, 1000, 1000R	G2
	Outlander MAX	450, 570	G2L
	Outlander MAX	650, 850, 1000, 1000R	G2
	6x6, 6x6 MAX	450	G2L
2020	6x6, 6x6 MAX	650, 1000	G2
	Renegade	570, 850, 1000, 1000R	G2S



G2L 6x6



G2 6x6



G2



G2L



G2S



G1



G1S

LinQ SYSTEM™

EASY ON EASY OFF CARGO

A BRP exclusive, LinQ is a tool-less system for near-instant installation of accessories. Quickly, easily install and remove LinQ accessories to transform your machine to fit the moment.



**FIT &
COMPATIBILITY**



**QUALITY &
RELIABILITY**



**STYLE &
VISION**



YOUR ADVENTURE, OUTFITTED

LinQ trunk boxes, rack extensions, bags, baskets, and gear grips attach quickly for your next expedition.



TOOL-LESS

Twist LinQ fasteners and go!



LinQ ACCESSORY TYPES

- **LinQ** with 16" base accessories are mounted with LinQ anchors 16 inches apart, ideal for Can-Am ATVs and SSVs, Sea-Doo watercraft, and Ski-Doo snowmobiles.
- **LinQ** with 36" base accessories are most commonly used as part of LinQ racks for Can-Am Off-Road vehicles.

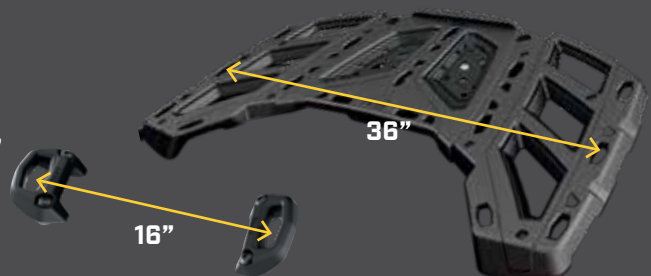

LinQ SYSTEM™ ACCESSORIES

- No tools needed: Quickly install and remove accessories by hand
- Equip your Can-Am for specialized tasks in no time
- Sturdy mounting system that holds up to the roughest terrain

Compatibility/Requirements





Outlander 450/570

Outlander

Renegade









LinQ ACCESSORIES WITH 16" BASE P. 11

- LinQ anchors mounted 16 inches apart, center-to-center.
- Lower loading capacity than the 36" base accessories.
- Can be used on Can-Am ATV and SSV vehicles, Sea-Doo watercraft and Ski-Doo snowmobiles.





	LinQ 4.2 GAL (16 L) COOLER 295100698	Not compatible	LinQ Anchor Adaptor Kit 715004960	LinQ Luggage Rack 715001734 + LinQ Anchor Adaptor Kit 715004960
	LinQ TOOL BOX 715004301			
	LinQ SR 5.5 GAL (21 L) BAG 860201740			
	LinQ 4.5 GAL (17 L) SPORT BAG 860201678			
	New LinQ DRY BAG 715002875			

LinQ ACCESSORIES WITH 36" BASE P. 12-15

- Mount on LinQ racks often used by Can-Am ORV vehicles.
- Higher loading capacity than the 16" base accessories.
- Usage is limited to Can-Am ORV vehicles.

	LinQ 12 GAL (45 L) CARGO BOX 715003879	LinQ Base 715002350	No further requirements	LinQ Luggage Rack 715001734
	LinQ 23 GAL (86 L) GAL TRUNK BOX 715004923			
	LinQ 32 GAL (121 L) TRUNK BOX 715001747 / 715001749 (MAX)	Not compatible		
	LinQ 11.5 GAL (43 L) AUDIO CARGO BOX 715003018	LinQ Base 715002350		
	LinQ 8 GAL (30 L) COOLER BOX 715004778 • Black / 715004698 • Grey	Not compatible		
	LinQ PREMIUM STORAGE BAG BY OGIO 715002923 • Black / 715003248 • Camo	LinQ Base 715002350		
	LinQ HEAVY-DUTY BASKET 715001215			
	LinQ LOW PROFILE BASKET 715004282			

LinQ RACKS & HOLDERS P. 25-27

	LinQ 4" (10 CM) RACK EXTENSION 715001711 • Silver / 715001665 • Black	Not compatible *Alternative 5" or 8" Rack Extensions (715001913 or 715001914) are available for G2L	No further requirements	LinQ Luggage Rack 715001734
	LinQ 6" (15 CM) RACK EXTENSION 715001712 • Silver / 715001671 • Black			
	LinQ MOUNTED GEAR GRIPS 715001351	Not compatible *Alternative Gear Grips by Kolpin (715001421) are available for G2L		
	LinQ TOOL HOLDER 715003059	LinQ Base 715002350		
	LinQ GUN BOOT RACK 715002112 / 715002113	Not compatible *Alternative Gun Boot Racks (715001918 or 715001919) are available for G2L		Not compatible

Some products shown may not be available or homologated in your country. Contact your BRP dealer for local details.



BETTER RIDE,
ADDED CAPABILITY,
MORE STORAGE:
WHAT'S NOT
TO LOVE?

LinQ ACCESSORIES WITH 16" BASE

OUTLANDER | RENEGADE

LinQ 4.2 GAL (16 L) COOLER

- Rotomolded construction for exceptional rigidity and durability.
- Premium-quality foam insulation for optimal ice retention.
- Marineized for salt water purposes.
- See table for installation location and requirements.

G2, G2S
295100698

\$299.99



EXPERT CHOICE

One of the most versatile and popular coolers on the market made for rugged use.

LinQ TOOL BOX

- High precision injected HDPE construction provides rigidity and durability.
- 5 Gal (19 L) maximum capacity.
- Weather-resistant, sealed and lockable cover.
- LinQ Cargo Base Kit included (860201806).
- Marineized for salt water purposes.
- See table for installation location and requirements.

G2, G2S
715004301

\$199.99



SR 5.5 GAL (21L) LinQ BAG

- Semi-rigid expandable bag.
- 5.5 Gal (21L) capacity.
- LinQ Cargo Base Kit included (860201801).
- See table for installation location and requirements.

G2, G2S
860201740

\$199.99



New LinQ 4.5 GAL (17 L) SPORT BAG

- 17-liter 4.5 Gal (17 L) capacity.
- Rigid bottom, semi-rigid top.
- See table for installation location and requirements.
- LinQ Cargo Base Kit included.

G2, G2S
860201678

\$199.99



New LinQ DRY BAG

- Fully waterproof roll-top dry bag will securely store and confine your equipment.
- LinQ mounted using heavy-duty rigid plastic base.
- High capacity storage solution 10.6 Gal (40L).
- Bottom foam liner for additional equipment protection.
- Integrated handle for easy transportation on/off the vehicle.
- LinQ Cargo Base Kit included (860201806).
- Marineized for salt water purposes.
- See table for installation location and requirements.

G2, G2S
715002875

\$325.99





LinQ 12 GAL (45L)
CARGO BOX

5" (13 CM) RACK
EXTENSION

LinQ
23 GAL (86L)
TRUNK BOX



LinQ ACCESSORIES WITH 36" BASE

OUTLANDER | RENEGADE

LinQ 12 GAL (45L) CARGO BOX

- LinQ mounted for easy on, easy off installation.
- Holds cargo safely and securely while riding.
- See table for installation location and requirements.

G2 (front only for 6x6 & MAX models 2013-2014), G2L, G2S

715003879

\$380.00



LinQ 23 GAL (86L) TRUNK BOX

- LinQ mounted for easy on, easy off installation.
- Lockable and weather-resistant.
- Holds cargo safely and securely while riding.
- Comfort pads for passenger.
- See table for installation location and requirements.

G2 (except 6x6 models), G2L, G2S

715004923

\$506.99





LinQ ACCESSORIES WITH 36" BASE

OUTLANDER | RENEGADE

LinQ 32 GAL (124L) TRUNK BOXES

Seamless integration with vehicle

- Built from the design stage to specifically match your Can-Am vehicle.
- Totally cohesive design eliminates the need to modify your vehicle in any way*.
- Rear tail light.

Color-keyed panels

- Colored Trunk Box Panels & Camo Decals are available to match your Outlander (sold separately).

Easy quick-attach installation

- Equipped with the LinQ System, the rear trunk box plugs in and out in seconds.
- Instantly transforms your vehicle to suit the need of the moment.

Unparalleled storage

- 32 Gal (124L) load capacity with contiguous unobstructed space to maximize storage room and access to the trunk's interior.

Built tough

- Made of injection-molded polyethylene, double walled in critical areas.

Dust and weather proof

- The fully sealed lid protects your belongings from dust, moisture and the elements.

Lockable

- Built-in lockable barrel.



Choose from 10 different colors to perfectly match your vehicle!

LinQ: EASY ON EASY OFF CARGO

ACCESSORIES

LinQ 32 GAL (124L) TRUNK BOX

- LinQ Retrofit Adaptor Plate (715001334) is required for G1 models.
- Trunk Box Panels available in many colors to match your vehicle (sold separately).
- See table for installation location and requirements.

G2 (except MAX models & 6x6).

G2S

715001747

\$616.99

LinQ 32 GAL (124L) TRUNK BOX FOR OUTLANDER MAX

- Passenger comfort is ensured on active rides as well as longer recreational rides thanks to the ergonomically designed passenger padding comfort-fitted with a portion made of closed cell foam that won't absorb water.
- Very easy to embark even when driver is seated.
- Trunk Box Panels available in many colors to match your vehicle (sold separately).

G2 (MAX models only except 6x6 models)

715001749

\$688.00

EUROPEAN VERSION (EC compliant)

- No rear tail light.

715001750

\$618.99



EXPERT CHOICE

Add lockable storage, style, and passenger comfort—no tools needed.

LinQ 32 GAL (124L) TRUNK BOX PANELS

- Color panels to match the 32 Gal (124L) LinQ Trunk Box to your vehicle.

LinQ 32 Gal (124L) Trunk Boxes

■ 715001391 • Black	\$51.99
■ 715001392 • Yellow	\$53.99
■ 715001395 • Viper Red	\$55.99
■ 715002481 • White	\$69.99
■ 715002480 • Light Grey	\$69.99
■ 715002984 • Octane Blue	\$72.99
■ 715002985 • Manta Green	\$72.99
■ 715002986 • Can-Am Red	\$72.99
■ 715006119 • Orange Crush <small>New</small>	\$90.99
■ 715006120 • Squadron Green <small>New</small>	\$90.99

EUROPEAN VERSION (EC compliant)

- No rear tail light

■ 715001398 • Yellow	\$56.99
■ 715001397 • Black	\$65.99
■ 715002482 • Light Grey	\$69.99
■ 715002483 • White	\$69.99
■ 715006121 • Can-Am Red <small>New</small>	\$90.99
■ 715006122 • Manta Green <small>New</small>	\$90.99
■ 715006123 • Orange Crush <small>New</small>	\$90.99
■ 715006124 • Viper Red <small>New</small>	\$90.99

CAMO DECALS FOR BLACK TRUNK BOX PANELS

(Not illustrated)

- Camo pattern perfectly matches your camo vehicle.

LinQ 32 Gal (124L) Black Trunk Box Panel

■ 715002975 • Mossy Oak Break-Up Country Camo	\$81.99
■ 715001683 • Next G-1 Vista Camo	\$81.99



715002975



715001683

*WARNING: You should never accessorize your Can-Am off-road vehicle with accessories not approved by BRP because your vehicle may no longer meet certain safety and construction standards. This situation could increase the risk of severe injury or death and render your vehicle not legal for use.

TAKE ON THE TOUGH JOBS WITH TASK-FOCUSED UPGRADES THAT ALLOW YOUR CAN-AM ATV VEHICLE TO WORK SMARTER & HARDER



LinQ ACCESSORIES WITH 36" BASE

OUTLANDER | RENEGADE

LinQ 11.5 GAL (43L) AUDIO CARGO BOX

- Mounts on/off easily to hold/carry cargo safely and securely.
- The Bluetooth enabled receiver and 6.5" (16.5 cm) speakers are smartly concealed and integrated in the cover.
- Automatic shut-off function protects your battery by turning the system off after 10 minutes of inactivity.
- Backlit control panel perfect for night riding.
- Water-resistant speakers.
- Delivers the best sound quality on the market to sweeten your ride courtesy of a built-in full range high-efficiency amplifier.
- See table for installation location and requirements.

G2 (front only for 6x6 & MAX models 2013-2014), G2L, G2S

715003018

\$994.99



Quickly attach or remove for ultimate sound and added storage, anytime.

LinQ 8 GAL (30L) COOLER BOX

- LinQ mounted for easy on, easy off installation.
- Rotomolded construction provides exceptional rigidity and durability.
- Premium-quality foam insulation for optimal ice retention.
- Integrated, fully-removable compartment protects food.
- Robust rubber latches keep the cover tightly closed.
- Weather-resistant.
- Convenient drain plug.
- See table for installation location and requirements.

G2 (except 6X6 models), G2S

715004778 • Black

\$633.99

G2 (except 6x6 models), G2S

715004698 • Grey

\$633.99



Some products shown may not be available or homologated in your country. Contact your BRP dealer for local details.



LinQ ACCESSORIES WITH 36" BASE

OUTLANDER | RENEGADE

LinQ PREMIUM STORAGE BAG BY OGIO

- Tool-less installation and removal thanks to the LinQ System.
- 17.2 Gal (65 L) capacity semi-rigid cargo bag ideal for carrying anything you need on your vehicle.
- Buckle and elastic closure with a rubber seal that protects dust from entering the bag.
- 3-section lid for partial or full access to your bag.
- Inside separators for optimal bag organization.
- See table for installation location and requirements.

G2 (except 6x6 models), G2L, G2S

715003248 • Mossy Oak Break-Up Country Camo

715002923 • Black

\$813.99

\$688.00



Inside separators for optimal bag organization

LinQ HEAVY-DUTY BASKET

- Made of high-strength, low-alloy steel.
- LinQ mount for easy on, easy off installation.
- Can be placed on both front and back racks of vehicle.
- See table for installation location and requirements.

G2, G2L (front only for MAX & 6x6 models), G2S

715001215

\$380.00



Superior build strength and high-walled sides for extra secure load capacity.

LinQ LOW PROFILE BASKET

- Low profile, open basket increases cargo space.
- Perfect for easy access to tools, rope, winch and plow accessories.
- Multiple bungee cord and tie-down anchor points.
- Made of impact-resistant injected polypropylene.
- See table for installation location and requirements.

G2, G2L (front only for MAX & 6x6 models), G2S

715004282

\$289.99



LinQ STORAGE BOX
2 GAL (7.5L)

EASY LOADS IT:
LinQ ACCESSORIES
MOUNT SECURELY
IN SECONDS



LinQ ACCESSORIES

OUTLANDER | RENEGADE

New LinQ ANCHOR ADAPTOR KIT

- Allows the installation of accessories with LinQ base of 16" on LinQ racks.
- Tool-less installation and removal.
- For G2S, the LinQ Luggage Rack (715001734) is required for installation.

G2, G2S
715004960

\$108.99



LinQ BASE

- Made of polypropylene glass fiber.
- Allows you to install LinQ accessories.
- Sold in pack of 4.

G2L
715002350

\$35.99



LinQ REPLACEMENT PARTS

- Unique mounting fastener usable on any LinQ System accessory.
- Tool-less installation and removal.
- Sold in pairs.

715001707

\$36.99



SOFT STORAGE BAG

- 3-section bag.
- Transport gear in a weatherproof bag.
- 11.8 Gal (45L) capacity soft cargo bag designed with vehicle's rack in mind to maximize potential storage.
- LinQ Luggage Rack (715001734) is required for G2S.

G2, G2L, G2S
715003759 - Black

\$253.99



STORAGE 2.6 GAL (10L) BAG

- Roll-top dry bag for fully protecting your cargo from the elements.
- Fits in rear compartment of your vehicle.

269502121

\$55.99



Some products shown may not be available or homologated in your country. Contact your BRP dealer for local details.

GET REMARKABLE VERSATILITY, QUALITY,
AND FIT TO MATCH EVERYTHING YOUR
OUTLANDER 6X6 CAN DO





OUTLANDER 6X6

LOG BARS

- Log bars allow you to convert the cargo bed into a perfect transport space for 4' (120 cm) timber.
- The driver's safety is guaranteed by the protective front screen.

G2 (6x6 models only)

715001987

\$1,664.99



HARD TOP

- The hard top provides a 116 Gal (440L) cargo box.
- Locking secures your belongings.
- The cover raises assisted by gas cylinders.

G2 (6x6 models only)

715002394

\$1,489.99



New CARGO BOX POOL

- Transforms the flatbed into a large capacity cargo box for increased loading possibilities.
- Made of durable formed HDPE and shaped to maximize cargo space.
- Allows access to vehicle's water-resistant rear compartment.
- Designed for perfect fit and easy installation.

G2L (6x6 models only)

715005256

\$642.99



TAILGATE EXTENSION/DIVIDER

- The sturdy tailgate extension provides a 10" (25 cm) extension to the cargo space.
- Thanks to the longer cargo bed, even large loads pose no problem.
- With the help of LinQ quick locks, the extension also acts as a solid space divider for the cargo bed.

G2 (6x6 models only)

715002017

\$734.99



Some products shown may not be available or homologated in your country. Contact your BRP dealer for local details.



OUTLANDER 6X6

TARPAULIN

- Fitted to cover all of the items in your cargo box thoroughly.
- Prevents splash from entering cargo box.
- Easily removable for quick access.

G2 (6x6 models only)

715002416

\$560.99



18 GAL [70L] UTILITY BOX

- Wherever you go and whatever you do, this handy 18 Gal (70L) utility box is your mobile storage.
- The lid keeps your equipment safe from the elements in all conditions.
- Slides under the flatbed with handles for easy access.

G2 (6x6 models only)

715001999

\$749.99



CARGO BOX NET

- Solid net designed to hook to the bottom of the cargo box for secure and compact confinement of your cargo.

G2 (6x6 models only)

715001371

\$108.99



TAILGATE LIMITER KIT

- 2 L-shape brackets that hold the tailgate open horizontally.
- Keeps tailgate flush with the rest of the flatbed for longer oversized cargo.

G2 (6x6 models only)

715002080

\$123.13



CAN-AM WINDSHIELDS

Factory-designed wind and debris protection options with clear benefits for every Can-Am ATV rider.



FIT & COMPATIBILITY



QUALITY & RELIABILITY



STYLE & VISION



Tool-less fitment

Install base bracket and quickly remove windscreen when needed



Extra High

High

Low

ELEVATED PROTECTION

Pick the windscreen based on the conditions with three different sizes to match your vehicle perfectly.



100% integrated

Perfectly shaped, built and finished to seamlessly improve the way your ATV cuts through the wind.

CREATE YOUR ULTIMATE WIND PROTECTION IN 3 EASY STEPS



1 CHOOSE A DELUXE FAIRING COLOR

DELUXE FAIRING

- Innovative, richly-featured wind protection.
- Quick tool-less removal once base brackets are mounted on handlebar.
- 2 cup holders.
- GPS-mounting-kit-ready.
- Optional mirrors and auxiliary lighting.
- Requires low, high or extra high windshield.
- Tapered Handlebar Adaptor Kit is required for vehicles with 1 1/8" (28 mm) tapered aluminum handlebars.

G2 (except X mr & 6X6), G2L

715000935 • Yellow 2000

\$320.99

715001231 • Red Viper

\$361.99

715001232 • Black

\$320.99

715002479 • Light Grey

\$342.99

715006125 • Squadron Green **New**

\$361.99



EXPERT CHOICE

Color-keyed fairings add another dimension to your Outlander's look and performance.

CAMO DECALS FOR BLACK DELUXE FAIRING

(Not illustrated)

- Camo pattern perfectly matches your camo vehicle.

Deluxe Fairing

715002976 • Mossy Oak Break-Up Country Camo

715001684 • Next G-1 Vista Camo

\$81.99



715002975



715001683

TAPERED HANDLEBAR ADAPTOR KIT

(Not illustrated)

- Required to install Deluxe Fairing on an Outlander X-TP and on any vehicle equipped with 1 1/8" (28 mm) tapered aluminum handlebars.

Deluxe Fairing

715002470

\$43.99



2 CHOOSE THE WINDSHIELD HEIGHT ACCORDING TO YOUR RIDING STYLE

EXTRA HIGH WINDSHIELD

- 16" (41 cm) windshield provides the ultimate protection against the elements while touring.
- For wind protection and winter applications.
- Tool-less installation and replacement.

Deluxe Fairing

715000936

\$141.99

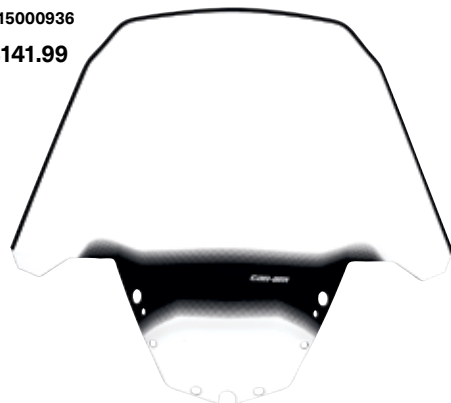

16" (41 cm)

HIGH WINDSHIELD

- 11" (28 cm) high, for wind protection and winter applications.
- Tool-less installation and replacement.

Deluxe Fairing

715001211

\$127.00



11" (28 cm)

LOW WINDSHIELD

- 6" (15 cm) windshield allows you to keep your vehicle looking sporty while giving you some protection from the elements and the possibility of enjoying directional lighting.
- Tool-less installation and replacement.

Deluxe Fairing

715001227

\$99.99



6" (15 cm)



3 COMPLETE WITH PERFECTLY INTEGRATED ACCESSORIES

AUXILIARY WINDSHIELD LIGHTING

- 2 premium LED spots for Deluxe Fairing for both increased output and directional lighting.
- 1,800 lumens.
- 2 10W LED Cree light kit.
- Long-range illumination up to 350' (107 m), drawing less than 1 amp per light.

Deluxe Fairing

715003115

\$547.99



DELUXE MIRROR KIT

- Improved mounting system.
- Wide rear view.
- Perfect fit with your Deluxe Fairing and Deluxe Windshield.

Deluxe Fairing

715002353

\$108.99





INTEGRATED AIRFLOW VENT REDUCES AIR TURBULENCE AND ENGINE RUMBLE AT HIGHER SPEEDS FOR LESS BUFFETING AND MORE COMFORT.

OUTLANDER | RENEGADE

WINDSHIELD KITS

- Made of polycarbonate with integrated vent to reduce air turbulence and rumble noise at high speeds for a quieter and smoother ride.
- Quick tool-less removal once base brackets are mounted on handlebar.
- Fits straight and tapered handlebars.
- Improved design for enhanced rigidity



1 EXTRA HIGH WINDSHIELD KIT

- 16" (41 cm) windshield.
- For ultimate wind protection and winter applications.

G2, G2L, G2S (except X mr models)

715003023

\$397.99



16" (41 cm)

2 HIGH WINDSHIELD KIT

- 11" (28 cm) windshield.
- For wind protection and winter applications.

AVAILABLE IN AUGUST 2019

G2, G2L, G2S (except X mr models)

715006382

\$343.99



11" (28 cm)

3 LOW WINDSHIELD KIT

- 6" (15 cm) windshield.
- Allows you to keep your vehicle looking sporty while giving you some protection from the elements.

G2, G2L, G2S (except X mr models)

715003021

\$271.99



6" (15 cm)

Some products shown may not be available or homologated in your country. Contact your BRP dealer for local details.

OUTLANDER | RENEGADE

HANDLEBAR WIND DEFLECTORS

- Rugged injected plastic construction with Can-Am logo.
- Include removable cap for air flow adjustment.
- Mounting kit sold separately.

G2, G2L, G2S

- 715000525 • Black / Yellow
- 715000537 • White / Black
- 715001706 • Black / Black
- 715000733 • Yellow / Black
- 715003811 • Can-Am Red / Black
- 715003812 • Manta Green / Black
- 715003813 • Orange / Black
- 715003814 • Octane Blue / Black

- 715006117 • Squadron Green/Black **New**
 - 715006118 • Viper Red/Black **New**
- \$45.99**

\$69.99



PASSENGER WIND DEFLECTORS

- These wind deflectors fit on the passenger handles and provide greater comfort while riding.
- Easy to install and remove.

G2 and G2L (MAX models only)

715001669

\$135.99



FULL WRAP ALUMINUM MOUNTING KIT

- Lightweight black die cast aluminum construction.
- Includes complete hardware.
- Handlebar wind deflectors sold separately.

G2, G2L, G2S

715001378

\$198.99



SHORT ALUMINUM MOUNTING KIT

- Lightweight black die cast aluminum construction.
- Includes complete hardware.
- Handlebar wind deflectors sold separately.

G2, G2L, G2S

715001379

\$108.99



MIRROR KIT FOR HANDLEBAR WIND DEFLECTORS

- Do not fit with Full Wrap Aluminum Mounting Kit (715001378).
- Sold in pairs.

Handlebar Wind Deflectors

860200080

\$48.99

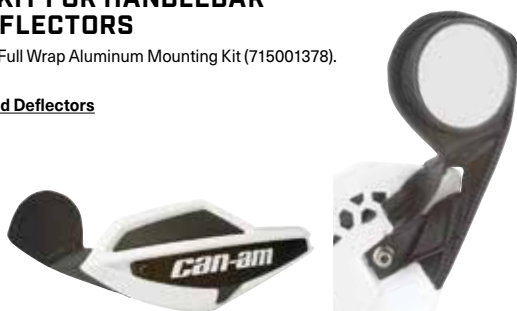

ALUMINUM TAPERED HANDLEBAR

- 7/8" - 1 1/8" (22 mm - 28 mm) tapered handlebar made of 6061-T6 aluminum.
- Includes all hardware, center steering foam and cover.

G2, G2L, G2S

715000550

\$180.99



XT HANDLEBAR PROTECTOR KIT

- Not compatible with Mud Strap (715003053).

G2, G2L

703100352

\$135.99



MIRRORS

- True vision surface 5" x 3" (13 cm x 8 cm).
- Matte finish.
- Stem includes 3/8" (10 mm) thread.

Left - 3/8" (10 mm)

- Bracket (715000190) is required for installation on DS 450.

- Bracket not required for installation on Outlander and Renegade.

709400406

\$45.99

Right - 3/8" (10 mm)

- Bracket (715000190) required except for vehicles with right hand break.

709400523

\$50.00



COMFORTABLE
DRIVER &
PASSENGER
SEATING
OPTIONS FOR
ALL RIDERS



OUTLANDER

DRIVER BACKREST

- Provides the rider's back with that extra support that makes riding that extra mile way more comfortable.
- Adjusts horizontally to match the driver's height and preference.
- Mounts and locks in firmly onto the vehicle.

G2 (except 6x6 & MAX models)

715003940

\$397.99

G2 2015 & up, G2L (MAX models only, except 6x6 models)

715003942

\$397.99

G2L (except MAX models)

715003941

\$397.99

G2 (6x6 models only, except Max)

715003611

\$380.00



OUTLANDER MAX PASSENGER SEAT KIT

- Perfect to replace used or damaged passenger seat.

G2 2015 and up, G2L (MAX models only)

715002373

\$1,022.99



AT THE JOBSITE OR ON AN ADVENTURE, LinQ RACKS MAKE IT EASIER TO CARRY THE LOAD



RACKS & HOLDERS

OUTLANDER | RENEGADE

LinQ RACK EXTENSION

- Fits front or rear.
- Strong and durable.
- Helps keep cargo securely in place.
- Easy and tool-less installation thanks to the LinQ System.
- Anti-corrosion coating with durable powder coat finish.
- LinQ Luggage Rack (715001734) is required for G2S.

G2, G2S

4" [10 CM]

715001711 • Silver 715001665 • Black

\$290.99

\$279.99

6" [15 CM]

715001712 • Silver 715001671 • Black

\$290.99

\$287.99



Twist & Go installation for adding cargo capability in seconds.





OUTLANDER

RACK EXTENSION

- Fits front or rear.
- Made of carbon steel.
- Provides tie-down points to secure cargo on racks.
- Easy installation on tubular rack.
- Anti-corrosion coating with durable powder coat finish.

G2L

5" (13 CM)

715001913

\$189.99



8" (20 CM)

715001914

\$217.99



Durable extensions with multiple attachment points and work-ready finish.

RENEGADE

REAR ALUMINUM RACK

- 30 lb (14 kg) capacity.
- Compact, lightweight aluminum construction.
- Engraved Can-Am logo.
- Stamped 5052 aluminum center plate.
- Easy to install.

G2S

715001360

\$294.00



LinQ LUGGAGE RACK

- Bolt-on rack.
- Enables use of LinQ mounted accessories on the G2S.

G2S

(except X mr models)

715001734

\$435.00





OUTLANDER

GUN BOOT RACK

- Made of steel.
- Designed for the tubular rack.
- For use with Gun Boot 6.0 Impact by Kolpin.
- Can be mounted to either side of the vehicle.

G2L (except MAX models)

715001918

\$207.99

G2L (MAX models only)

715001919

\$207.99



GUN BOOT 6.0 IMPACT⁺ BY KOLPIN⁺

- Extra room for pistol-grip-type weapons and small bipods.
- Easily fits firearms up to 51" (130 cm) in total length.
- Provides ample room for 2 3/8" (60 mm) scopes.
- Hatchback design allows easy access.
- Ergonomically designed handle and molded attachment points for sling.

G2, G2L

715001419

\$144.99

- Snap-close cover with locking capability.
- Designed to accommodate left and right hand bolt-action rifles and shotguns.
- Includes removable, shock absorbing foam and nylon Impact liner for superior interior protection.
- Requires appropriate mounting kit for installation.



LinQ GUN BOOT RACK

(Not illustrated)

- This lightweight Gun Boot Rack can be mounted on either side of your Outlander using the tool-less LinQ System.
- For use with Gun Boot 6.0 Impact by Kolpin.

G2 (except MAX, 6X6 & X mr 1000)

715002112 • Black

\$244.99

G2 (MAX & X mr 1000 models only)

715002113 • Black

\$235.99

MULTI-FIT HOLDER

- Open U-shaped bracket for carrying tools (shovel, axe) and hunting weapons (rifle, bow) that are safely secured, but easily accessible.
- Easy installation on tubular rack, extension racks, basket or bumpers.
- For G2, the LinQ Rack Extension (715001711) is required.
- Sold in pairs.

G2, G2L

Single

715002354

\$90.99

Double

715001945

\$127.00



OUTLANDER | RENEGADE

GEAR GRIPS BY KOLPIN

- Durable, flexible grips cushion and protect while providing a custom fit for a variety of items from 1" to 4" (2.5 cm to 10 cm) in diameter.
- Heavy-duty design for carrying bows, fishing poles, rakes, farm tools and more.
- Quick-release button opens grip quickly for easy access to gear.
- Heavy-duty base system built for the toughest adventures.
- Easy installation on tubular racks, extension racks, brackets or bumpers.
- Sold in pairs.

G2L

715001421

\$127.00



LinQ MOUNTED GEAR GRIPS BY KOLPIN

(Not illustrated)

- Same features as Gear Grip by Kolpin (715001421).
- Make transporting your tools a snap by combining the Gear Grips with the LinQ System.
- 360° orientation.
- LinQ Luggage Rack (715001734) is required for G2S.

G2, G2S

715001351

\$168.99

LinQ TOOL HOLDER

- Ultra-versatile tool holder.
- Convenient swivel-latch allows tools to be stored in any orientation.
- LinQ Luggage Rack (715001734) is required for G2S.
- Sold in pairs.

G2, G2S, G2L

715003059

\$90.42



OUTLANDER | RENEGADE

HMWPE SKID PLATES

Our Plastic Plates glide smoothly and silently over obstacles, offering great protection in rough terrain. Made of 1/4" (6 mm) thick abrasion-resistant thermoformed High Molecular Weight Polyethylene (HMWPE).

- ✓ Lighter than aluminum
- ✓ Superior stress crack resistance
- ✓ High impact strength



715004806

SKID PLATES

ACCESSORIES

Offer your Outlander or Renegade the full protection kit or get them individually	G2						G2L		G2S	
	2016 & PRIOR		2017-2018		2019 & UP		Except MAX models	MAX models only	2017-2018 MODELS	2019 & UP
	Except MAX & X mr 1000R models	MAX & X mr 1000R models only	Except MAX & X mr 1000R models	MAX & X mr 1000R models only	Except MAX & X mr 1000R models	MAX & X mr 1000R models only				
HMWPE SKID PLATE PROTECTION KIT	715004214	715004215	715004209	715004210	715004806	715004807	715004211	715004212	715004213	715004809
INDIVIDUAL HMWPE SKID PLATES										
① A-ARM PROTECTORS	715002924	715002924	715002924	715002924	715004822	715004822	715002924	715002924	715002924	715004822
② UNDERBELLY PLATES	715002926	715002927	715002926	715002927	715002926	715002927	715002928	715002929	715002974	715002974
③ TRAILING ARM PROTECTORS	715002925	715002925	715003466	715003466	715004823	715004823	715003466	715003466	715003466	715004823

Some products shown may not be available or homologated in your country. Contact your BRP dealer for local details.

OUTLANDER

ALUMINUM SKID PLATES

For ultimate durability and strength, all our Aluminum Skid Plates are made with High Strength 5052 H32 Aluminum 3/16" (4.5 mm) thick.

- ✓ Ultimate durability
- ✓ High strength



715004197

SKID PLATES

ACCESSORIES

Offer your Outlander the full protection kit or get them individually	G2						G2L	
	2016 & PRIOR		2017-2018		2019 & UP		ANY YEAR	
	Except MAX & X mr 1000R models	MAX & X mr 1000R models only	Except MAX & X mr 1000R models	MAX & X mr 1000R models only	Except MAX & X mr 1000R models	MAX & X mr 1000R models only	Except MAX models	MAX models only
HMWPE SKID PLATE PROTECTION KIT	715002137	715002138	715004197	715004198	New 715004804	New 715004805	715004199	715004200

INDIVIDUAL HMWPE SKID PLATES								
① A-ARM PROTECTORS	715001667	715001667	715001667	715001667	New 715004820	New 715004820	715001667	715001667
② FRONT SKID PLATE	715000926	715000926	715000926	715000926	715000926	715000926	715001906	715001906
③ CENTRAL SKID PLATE	715002078	715002078	715002078	715002078	715002078	715002078	715002078	715002078
④ FOOTWELL PROTECTOR PLATES	715000922	715000922	715000922	715000922	715000922	715000922	715000922	715000922
⑤ TRAILING ARM PROTECTORS	715001129	715001129	715003741	715003741	New 715004821	New 715004821	715003741	715003741
⑥ REAR DIFFERENTIAL PROTECTORS	715000920	715000920	715000920	715000920	715000920	715000920	715000920	715000920
⑦ REAR SKID PLATE	715002028	715002029	715002028	715002029	715002028	715002029	715002028	715002029

RENEGADE

ALUMINUM
SKID PLATES

For ultimate durability and strength, all our Aluminum Skid Plates are made with High Strength 5052 H32 Aluminum 3/16" (4.5 mm) thick.

- ✓ Ultimate durability
- ✓ High strength



715004201



Offer your Renegade the full protection kit or get them individually

G2S

ALUMINUM SKID PLATE PROTECTION KIT

NOT COMPATIBLE ON X MR MODELS

2016 & PRIOR

715002139

2017-2018

715004201

2019 & UP

New
715004808

INDIVIDUAL ALUMINUM SKID PLATES

① A-ARM PROTECTORS

715001667

715001667

New
715004820

② FRONT SKID PLATE

715000925

715000925

715000925

③ CENTRAL SKID PLATE

715002078

715002078

715002078

④ FOOTWELL PROTECTOR PLATES

NOT COMPATIBLE ON X MR MODELS

715001359

715001359

715001359

⑤ TRAILING ARM PROTECTORS

715001129

715003741

New
715004821

⑥ REAR DIFFERENTIAL PROTECTORS

715000920

715000920

715000920

⑦ REAR SKID PLATE

715002028

715002028

715002028

OUTLANDER 6X6

HMWPE & ALUMINUM SKID PLATES

Our Plastic and Aluminum Plates glide smoothly and silently over obstacles, offering great protection in rough terrain.

HMWPE

Made of 1/4" (6 mm) thick abrasion-resistant thermoformed High Molecular Weight Polyethylene (HMWPE).

- ✓ Lighter than aluminum
- ✓ Superior stress crack resistance
- ✓ High impact strength

ALUMINUM

Made with High Strength 5052 H32 Aluminum 3/16" (4.5 mm thick).

- ✓ Ultimate durability
- ✓ High strength



SKID PLATES

ACCESSORIES



Offer your Outlander 6x6 a full protection solution by combining our skid plates or get them individually.

	G2 6X6			G2L 6X6
	2016 & PRIOR	2017 - 2018	2019 & UP	ANY YEAR
INDIVIDUAL HMWPE SKID PLATES				
① HMWPE A-ARM PROTECTORS	715002924	715002924	715004822	715002924
② HDPE FULL UNDERBELLY SKID PLATE	715003646 (Except MAX) 715003647 (MAX only)	715003646 (Except MAX) 715003647 (MAX only)	715003646 (Except MAX) 715003647 (MAX only)	715005259 (MAX only)
③ HMWPE TRAILING ARM PROTECTORS	715002925	715003466	715004823	715003466
INDIVIDUAL ALUMINUM SKID PLATES				
① ALUMINUM A-ARM PROTECTORS	715001667	715001667	New 715004820	715001667
② ALUMINUM FULL UNDERBELLY SKID PLATE	—	—	—	—
③ ALUMINUM TRAILING ARM PROTECTORS	715001129	715003741	New 715004821	715003741

CAN-AM BUMPERS

The strength to endure and the character to wear well—our bumpers are ready for it.

BUMPERS & GUARDS

ACCESSORIES



FIT & COMPATIBILITY



QUALITY & RELIABILITY



STYLE & VISION



HEAVY-DUTY LOOKS

Real capability—with a durable fit and finish you'll just have to age yourself



DURABILITY SLEEK ENOUGH TO WORK ALONGSIDE YOUR HERD

COMPLETE RANCHER PROTECTION KIT

See p. 34



100%

integrated

Designed to seamlessly integrate with the style, fit, finish, and capability of your ATV.



Durable textured finish

For long life and better resistance to scratches and corrosion.



OUTLANDER

XT BUMPERS

- Provide additional protection against obstacles.
- Tough and durable, can be added on base Outlander model to convert vehicle into XT model.
- Standard on XT model.
- Large tube construction with textured black finish and metal corners.

XT FRONT BUMPER

G2
715004837
\$304.99



XT REAR BUMPER

G2
715004920
\$262.99



- Large tube construction.
- Protects vehicle frame against obstacles.

XT FRONT BUMPER

• Winch compatible.
G2L
715001910
\$240.99



XT REAR BUMPER

G2L
715001911
\$189.99





RANCHER REAR BUMPER

WORK AND MOVE CONFIDENTLY WITH HEAVY-DUTY, HERD-FRIENDLY PROTECTION OPTIONS



RANCHER FRONT BUMPER

OUTLANDER

COMPLETE RANCHER PROTECTION KIT

- These heavy-duty bumpers and fender guard are designed to pull double duty: protect your ATV and anything it comes in contact with, while also enhancing the look of your ATV.
- Made tough and designed to deliver a rugged appearance, together they offer front, rear and full side protection for farmer, rancher and forestry applications.
- Requires Body Side Protector Extensions (715003460) for installation on MAX models.

This kit includes:

- Rancher Front Bumper (715003461)
- Rancher Rear Bumper (715003462)
- Body Side Protector (715003459)

G2, G2L (except X mr & 6x6 models)

715003459

\$524.99

RANCHER FRONT BUMPER

- The low front end protection and plates allow you to use your ATV within cattle herds and guard the safety of both the vehicle and the animals.
- The flat front portion facilitates gently prodding cattle or pushing light objects, e.g. closing a fence.
- The full frontage coverage extends to provide an extra layer of defense to your headlights and radiator.
- Inside and outside anti-corrosion coating with durable powder coat finish.
- Not compatible with track systems, plows and front hitch.

G2, G2L (except X mr models)

715003461

\$479.00



RANCHER REAR BUMPER

- Ideal for using your ATV within cattle herds and guard the safety of both the vehicle and the animals.
- Coverage extends to provide an extra layer of defense to your tail lights.
- Inside and outside anti-corrosion coating with durable powder coat finish.
- Not compatible with track systems.

G2, G2L (except 6x6 models)

715003462

\$408.99



Some products shown may not be available or homologated in your country. Contact your BRP dealer for local details.

OUTLANDER

BODY SIDE PROTECTOR

- The heavy-duty fender guard designed to pull double duty: protecting your ATV and also enhancing the look of your ATV.
- Made tough and designed to deliver a rugged appearance, this fender guard offers full side protection for farmer, rancher and forestry applications.
- Built of durably bold 1.25" (3 cm) diameter steel-tube construction, with inside and outside anti-corrosion coating with durable powder coat finish.
- Not compatible with Self Clearing Footwell.
- XT Front and Rear Bumpers or Rancher Front and Rear Bumpers are required for installation.
- Requires Body Side Protector Extensions (715003460) for installation on MAX models.

G2, G2L, with Rancher bumpers
(except X mr & 6x6 models)

715003459
\$524.99

G2L with XT bumpers
(except X mr & 6x6 models)

715003614
\$578.99

G2 with XT bumpers
(except 6x6 models)

715004940
\$542.99



BODY SIDE PROTECTOR EXTENSIONS

(Not illustrated)

- This specially designed extension for the Body Side Protector is made specifically to fit and seamlessly integrate the look of Outlander MAX models.

G2, G2L
(MAX models only)

715003460
\$108.99

EXTREME FRONT BUMPER

- Ultra-sturdy build.
- Enhances front-vehicle protection.
- Compatible with XT Front Bumper.
- Fits the Apache™ 360 Track System (when side panels are removed).

G2	G2L
• Not compatible with Front Hitch.	715004279
715001286	\$406.99
\$405.99	



715001286



715004279

OUTLANDER 6X6

New FLATBED PROTECTION TUBES

- Bolt-on bumpers for the sides of the 6x6 flatbed.
- Protect the exterior plastic components of the flatbed from rocks, trees and other obstacles when traversing enclosed areas or loading cargo onto the bed.

G2L 6x6	G2 (6x6 models only)
715005266	715002030
\$506.99	\$741.99



715005266



715002030

RENEGADE

RENEGADE EXTREME FRONT BUMPER

- Enhanced vehicle front protection.
- Required as a mounting point for Radiator Relocator (715001929).

G2S
715002469
\$388.99



OUTLANDER

FENDER FLARES

- Kit designed to deliver extra protection from dirt and debris, therefore a must if you enjoy riding in the mud.
- Made of injected plastic that hugs your vehicle fenders perfectly.
- Gives vehicle added flair for that rugged cool look.
- Includes front and rear extensions and all mounting hardware.

**G2 (except with 30" tires)
(except 6x6 models)**

715001764

\$183.99

G2L

- Not compatible with
European vehicles

715001909

\$194.99

**G2L European
vehicles only
2015 & up**

715004487

\$186.99

**G2 (with 30" tires)
(except 6x6 models)**

• Standard on G2 X mr
1000R.

715004250

\$235.99



FENDER FLARE EXTENSIONS

- Block terrain debris from kicking up onto you as you ride or damaging your vehicle thanks to these extra-large Fender Flare Extensions, which also include mud flaps for added protection from mud/snow, especially when riding with track kits.
- Made of High Molecular Weight Polyethylene (HMWPE) for advanced abrasion resistance.
- Include front and rear extensions.

G2 (except 6x6 models)

• Must be used with Fender Flare
for G2 (715001764).

715005111

\$361.99

G2L

• Must be used with Fender Flare
for G2L (715001909).

715003615

\$361.99



RENEGADE

FENDER FLARES

- Integrated extended Fender Flares for sporty look and full body protection from dirt and water.
- Include front and rear extensions and all mounting hardware.

G2S (except X mr models)

705012695

\$295.99



Some products shown may not be available or homologated in your country. Contact your BRP dealer for local details.



OUTLANDER | RENEGADE

HEATED GRIPS & THUMB THROTTLE COMBO

• Not compatible with Intelligent Throttle Control (iTC).

G2, G2L, G2S (except 2020 models equipped with 850 engine and 2019 & up models with 1000R engine, 6x6 models and T Category models)

715003250

\$312.99

• Compatible with Intelligent Throttle Control (iTC).

G2, G2L, G2S (2020 models equipped with 850 engine and 2019 & up models with 1000R engine, 6x6 models and T Category models)

715004815

\$416.00



Heat, where you want it. This popular upgrade takes the chill from cold, wet rides.

① LED dimmer facilitates reading temperature settings.

② 4 temperature settings with individual controls for thumb and grips. Returns to previous heat setting.

③ One-touch shutdown.

Wiring Cable (710004567) is required for installation on G2 and G2L.

WIRING CABLE

(Not illustrated)

• Required for installation of Heated Hand Grips & Throttle Combo.

G2L

710004567

\$18.07

HEATED VISOR OUTLET

- Strategically positioned on vehicle to maintain your agility.
- Optional visor outlet that delivers fog-free riding.
- Quick and easy installation.
- Sold individually.
- Heated Visor not included.

G2, G2L

715001246

\$90.99



OUTLANDER

HEATED PASSENGER GRIPS & VISOR OUTLET

- Replace your stock passenger handles.
- Dual temperature switch integrated into seat arm for 3-zone heated handles and grips.
- Heated visor outlet integrated into seat arm.

G2, G2L (MAX models only)

715001926

\$156.99

G2 (2013-2014)

(MAX models only)

715002116

\$380.00



OUTLANDER | RENEGADE

New ELECTRONIC DEVICE HOLDER

- Robust injected-polypropylene construction allows for the right fit and easy installation.
- Adjustable unit safely holds smartphones or small tablets with a length or width measuring between 2.9" (7.5 cm) and 5.1" (13.0 cm) with or without protective case.
- Integrated storage (0.6 Gal / 2.1L).
- Guiding wire grooves to pass charging cable through the lid.
- Possibility of relocating 12V power outlet or installing USB outlet in storage compartment (USB power outlet sold separately).
- Not compatible with windshields and Snorkel Kit.

G2, G2L (except 6x6 & X mr models)

715004919

\$217.99



Integrated storage
with access
to the dash
12V outlet for
device charging



CGX3 CAMERA

- 160° wide angle lens.
- Resolution options: From 3MP up to 20MP and VGA.
- Video resolutions available: 2.7K at 30 frames per second (FPS), 720P at 120/60/30 FPS, 1080P at 60/30 FPS and VGA at 240 FPS.
- Record videos in 4K UHD at 24 FPS, 2.7K QHD at 30 FPS and 720P at 120 FPS.
- Memory: Class 10 32GB Micro SD card.
- 2" (5 cm) capacitive touchscreen.

9700130090

\$633.99

- Li-ion battery capacity of 1050mAh, working time of 1/1.5 hours and charging time of 3 hours (2 batteries included).
- WiFi function remotely operates up to 33-49 ft (10-15 meters) with mobile devices and Cyclops app for Android and iOS.
- Waterproof up to 33 ft (10 meters) without a case.
- Features modes such as invert, time lapse, high speed and loop recording, motion detection, capture (while recording a video), burst and anti-sharing.
- Comes with 8 mounting accessories.



CGX3 GIMBAL CAMERA STABILIZER

(Not illustrated)

- 3-axis full 360-degrees precision: Eliminates shaky video and allows you to easily shoot pro-quality, cinematic-like footage with your Action Camera.
- Built-in Bluetooth 4.0.
- Independent APP to control the gimbal.
- Compatible with iOS 8.0 and Android 4.4 or above.
- Rechargeable battery.
- Rugged, full aluminum alloy.
- 5-way joystick and multi-function button for flexible operations and convenient switch.

9700160090

\$542.99

CGX3 POWER STICK MOUNT

(Not illustrated)

- 5200mAh of continuous power in your hand, when you need it.
- Rubberized silicone handle for comfort and grip.
- Power indicator light to let the user know when the battery is running low.
- Includes power hand grip, long screw, convert tripod mount, phone clip mount, USB mini cord, USB micro cord and adjustable strap.

9700100090

\$90.99

CGX3 LED LIGHT

(Not illustrated)

- Wide-Angle 300 Lumen Max. (5500K-6000K) by 3 LEDs.
- Waterproof, attachable light.
- Three modes of light: High, Low, Flashing.
- Rechargeable battery: 1050mAh.

9700200090

\$90.99

CGX3 SELFIE STICK

(Not illustrated)

- Easily take photos or record videos with the CGX3 Selfie Stick.
- This selfie stick is made tough for any sport or activity.

9700170090

\$36.99

BLUETOOTH HANDLEBAR SOUNDBAR BY MTX

- Bluetooth speaker with the unbeatable convenience of fingertip control.
- Rugged IP66-rated weather-resistant speaker designed for outdoor use.
- Driven by 150 watts of quality audio power.
- Seamless integration and operation from Bluetooth enabled devices.
- Includes input, ground and ignition wires, plus auxiliary port and 3.5" (8.89 cm) connector cable.
- Not compatible with XT Handlebar Protector Kit.

Note: We recommend you use 320 Kbps MP3 - 192-256 Kbps AAC or AIFF, WAV formats to match the potential of the speaker. More compressed formats will probably have degraded sound quality.

G2, G2L, G2S

219400840

\$730.99



USB POWER OUTLET KIT

- Recharges your electronic devices while riding* (smartphone, MP3, heating gear, etc.).
- Dual port USB connectors.
- The power outlet is not capable of recharging all device types while riding.

G2, G2L, G2S

219400510

\$47.99



MULTI POSITION LIGHT MOUNT KIT

- Multi-position plastic clamps that fit on various tubing sizes: 0.75" to 1.5" (19 mm to 38 mm).
- Required for the installation of the 2" (5 cm) Square LED Lights (2 x 10W).
- Kit includes tube clamp mounts and power cables.

G2 (except X xc), G2L, G2S

715004274

\$144.99





ALL LED LIGHTS ARE NOT CREATED EQUAL. BAJA DESIGNS LIGHTS ARE COVERED BY A LIFETIME WARRANTY.

LIGHTS & ELECTRICAL

ACCESSORIES

OUTLANDER

BAJA DESIGNS HIGH BEAM KIT

- Thanks to their direct bolt-on and plug-and-play installation right into the original high beam location, upgrading from your stock high beam lights to these powerful Baja Designs Squadron Pro LED Lights becomes child's play.
- Each spot is equipped with 4 Cree LEDs producing 4,900 lumens at 40 watts.
- Driving/Combo light pattern for smooth blend of light for both near field applications and distance.

G2

715004284

\$1,085.99



Plug-and-play lighting upgrade gives eye-opening visibility, anywhere.

OUTLANDER | RENEGADE

2" [5 CM] SQUARE LED LIGHTS (2 X 10 WATTS)

- 2 x 900 lumens 10W LED Cree light kit.
- Long-range illumination up to 350' (107 m), drawing less than 1 amp per light.
- Multi-Position Light Mount Kit is required for installation.
- Not EC compliant.

G2 (except X xc), G2L, G2S

715004293

\$289.99



RAM⁺ LED SPOTLIGHT

- 540 lumens LED light (9 Watt) heavy-duty spotlight standard-equipped with 1" (2.5 cm) diameter rubber-coated double ball and socket system.

G2, G2L, G2S

710005423

\$143.99



AUXILIARY WINDSHIELD LIGHTING

- 2 premium LED spots for Deluxe Fairing for both increased output and directional lighting.
- 1,800 lumens.
- 2 x 10W LED Cree light kit.
- Long-range illumination up to 350' (107 m), drawing less than 1 amp per light.

Deluxe Fairing

715003115

\$547.99



RENEGADE

CENTER CONSOLE DAY LIGHT

- Mountable on top end of center console.
- Enhances look of vehicle.

G2S (except X mr)

715000691

\$108.99



OUTLANDER | RENEGADE

JUMP STARTER

- IPX3 water-resistant and enclosed output ports.
- 4 LED battery indicators for easy read on battery charge level.
- Compact design, will conveniently fit in your backpack, glove box or any other storage compartment.
- Quickly starts vehicles in emergencies.
- Great for powersport vehicles, motorcycles and 4 and 6 cylinder vehicles.
- 2.4A + 1A/5V USB ports for fast charging of all USB devices, including smartphones, MP3 players and tablets.
- Smart cable provides protection against reverse polarity, short circuit, low voltage, high temperature and reverse charging.
- Built-in LED light (3 modes).
- Content: 300CA jump starter, SA858 smart cable clamp, MC-USB to USB charging cable, travel bag, user manual.

715005062

\$199.99

GARMIN† MONTANA† 680T GPS

- Rugged and waterproof, the Montana 680T is element-proof.
- 4" (10.2 cm) dual-orientation, sunlight-readable touchscreen and glove-friendly touchscreen display, to give you vivid colors and high-resolution images.
- 8-megapixel autofocus camera automatically geotags photos.
- Tracks both GPS and GLONASS satellites for improved positioning and typically faster fixes.
- Preloaded TOPO maps, plus 1-year BirdsEye Satellite Imagery subscription.
- 3-axis compass with barometric altimeter.
- Specific GPS cradle included (vehicle mounting kit required).
- Includes a preloaded map for US.

G2, G2L, G2S

715002830

\$1,202.99

GPS RAM MOUNT FOR HANDLEBAR

- Convenient bracket for installing the Garmin Montana GPS (not included) onto your unit's handlebar.

G2, G2L

715001985

\$105.00



OUTLANDER | RENEGADE

WARN⁺VRX

- Extreme IP68-rated waterproof sealing keeps the elements out.
- Durable all-metal construction.
- Black powder-coated finish and stainless steel fasteners for corrosion resistance.
- Robust new clutch design based on 70+ years of WARN 4WD hub lock know-how.

- Load-holding brake for great control.
- Smooth and reliable all-metal three-stage planetary gear train.
- Dash-mounted rocker control and corded remote.
- Limited lifetime warranty (mechanical), 3-year warranty (electrical).

New WARN VRX 25

- Pulling strength capability of 2,500 lb (1,134 kg).
- 50 ft. of 3/16" (15 m of 4.8 mm) wire steel cable.
- Cast aluminum fairlead.

G2, G2L, G2S

715006107

\$795.99



New WARN VRX 35

- Pulling strength capability of 3,500 lb (1 588 kg).
- 50 ft. of 3/16" (15 m of 4.8 mm) wire steel cable.
- Cast aluminum fairlead.

G2, G2L, G2S

715006108

\$859.99



New WARN VRX 35-S

- Pulling strength capability of 3,500 lb (1 588 kg).
- 50 ft. of 1/4" (15 m of 6.3 mm) synthetic rope.
- Cast aluminum fairlead.

G2, G2L, G2S

715006109

\$1,049.99



OUTLANDER

CAN-AM HD

- Heavy-duty 4-way roller fairlead.
- Ergonomic clutch handle.
- Rugged all-steel gears and bushings provide more torque and longer life.
- Automatic 100% load-holding brake.

New CAN-AM HD 2500 WINCH

- Pulling strength capability of 2,500 lb (1,134 kg).
- 50 ft. of 3/16" (15.2 m of 4.8 mm) wire steel cable.

G2, G2L

715006414

\$488.99



- Sealed solenoid for all-weather protection.
- Wired Remote Control sold separately.
- Weather sealed handlebar mounted switch.
- EC compliant.

New CAN-AM HD 3500 WINCH

- Pulling strength capability of 3,500 lb (1,588 kg).
- 50 ft. of 7/32" (15.2 m of 5.5 mm) wire steel cable.

G2, G2L

715006415

\$542.99



OUTLANDER 6X6

REAR WINCH KIT

- The remote-controlled rear winch is a godsend when you want to pull yourself out of a tough spot or move heavy loads.
- Includes a fully-sealed Warn winch and all wiring and hardware needed for an easy and quick installation.
- Pulling strength capability of 3,000 lb (1,361 kg).
- 50 ft. of 3/16" (15.2 m of 4.8 mm) wire steel cable.

G2 (6x6 models only)

715002484

\$1,795.99



OUTLANDER | RENEGADE

WARN HAWSE FAIRLEAD

- Double-powder-coated construction.
- Required to use the Synthetic Winch Cable (715004254) on Warn winches.
- To be used with synthetic winch cables only.

Warn winches

715004255

\$127.00

WINCH MOUNTING PLATE

- Adds functionality to your Renegade.
- Fits Can-Am winches by Warn.

G2S

715000927

\$155.99

WINCH ACCESSORIES KIT

- Get the most out of your winch.
- Double your pulling power, change your pulling direction and keep your winch in proper working order.
- Includes tree straps, snatch block, shackle and winching gloves.

715002409

\$204.00

WIRELESS REMOTE CONTROL

- The system is quick and easy to install, thanks to a wiring harness with an integrated antenna and all necessary mounting hardware.
- The system allows you to operate your winch from anywhere within a 50' (15.2 m) radius, increasing your recovery options.
- All components are weatherproof.

Warn winches

715002542

\$329.99

WIRED REMOTE CONTROL

- This kit allows winch owners to add the hand-held remote to their winch.
- EC compliant.

For ATVs with handlebar winch remote socket

710002270

\$108.99

ATVs without the winch remote socket

- Side panel Remote Socket (715003651) is required.

710001002

\$207.99

Can-Am HD winches

710004887

\$36.99

ROLLER FAIRLEAD

- Features top, bottom and side rollers for less cable wear and smoother operation from any direction for easier winching.

715000011 • Warn winches

\$199.99

705204571 - Can-Am HD winch

\$54.99

REPLACEMENT WIRE ROPE

- Play it safe, always carry a replacement wire rope.
- 3,500 lb (1,588 kg) pulling strength.

Can-Am HD 2500

- 50 ft. of 3/16" (15.2 m) of 4.8 mm wire rope.

705014983

\$34.99

ATV Warn winches

- 50 ft. of 7/32" (15.2 m) of 5.5 mm wire rope.

705009321

\$54.99

ATV Warn winches

- 50 ft. (15.2 m) aircraft grade steel wire.
- 7/32" (5.5 mm) diameter.

715006256

\$117.99

SYNTHETIC WINCH CABLE

- Easier to manipulate than steel cable.
- Replaces the original cable on any factory installed Warn winch or sold as an accessory by BRP.
- Kit includes synthetic rope and rock guard sleeve.
- Always use with new Hawse Fairlead (715004255).
- 50 ft. (15.2 m).
- 3,500 lb (1,588 kg) pulling strength.

ATV Warn winches

715004254

\$226.99

WARN REMOTE SOCKET

(Not illustrated)

- Winch remote socket, located on side panel, is required for wired remote control.

715003651

\$45.99

WINCH WIRE HARNESS

(Not illustrated)

- Required plug-and-go wiring to install Warn winch only.
- Not required for Can-Am HD winches.

G2L

715002453

\$72.99

HARDWARE ADAPTER KIT

(Not illustrated)

- Required to install Warn Winch Kit (715006107, 715006108, 715006109) on 2016 and up models.
- Required to install Can-Am HD 2500 Winch (715006414) and Can-Am HD 3500 Winch (715006415) on G2L 2017 and up models.

715003477

\$54.99

ADD TOWING CAPACITY
FOR ALL YOUR
UTILITY HARD WORK



OUTLANDER | RENEGADE

FRONT & REAR HITCH DRAWBAR

- Standard on 2" (5 cm) receiver hitch.
- It offers 1,500 lb (680 kg) of towing capacity.
- Hitch ball not included.

G2, G2L, G2S

715000972

\$128.99



RUBBER RECEIVER PLUG

- Rubber cap for 2" (5 cm) hitch receiver.

705204503

\$19.66



European Version

- Drawbar with 2" (5 cm) hitch ball.

705208131 (T Homologated)

\$343.99

REAR HITCH

- E-coat finish.
- Fixed hitch ball mounting bracket.
- Provides fixed mounting point for trailer ball to provide vehicle with towing capabilities.
- This hitch offers 1,500 lb (590 kg) of towing capacity.
- Hitch ball not included.

G2, G2L, G2S (except 6x6 models)

715001925

\$90.99



REAR RECEIVER HITCH

- E-coat finish.
- Does not affect ground clearance.
- Trailer ball not included.
- On 4X4 use, this hitch offers 1,654 lb (680 kg) of towing capacity.
- On 6X6 use, this hitch offers 1654 lb (750 kg) of towing capacity.
- Compliant with European T regulations.
- Not compatible with rear bumpers and G2L models.

G2S 2012 with 800R or 1000 engines.

G2S 2013 & up, G2L & G2

715005186

\$153.99



OUTLANDER

FRONT RECEIVER HITCH

- Front receiver hitch for Outlander with or without a winch.
- This hitch offers 1,500 lb (590 kg) of towing capacity.
- Allows you to maneuver your trailer easily in tight, confined areas.
- Hitch bar sold separately.
- Not compatible with Extreme Front Bumper, Rancher Bumper and ProMount Plows.

G2

715000921

\$153.99



OUTLANDER

OUTLANDER RADIATOR RELOCATOR KIT

- Relocates radiator to top mount position.
- Prevents cooling performance loss in muddy conditions.
- Uses existing radiator.
- Includes support, hardware and hoses.
- Engineered for easy cooling system bleeding and maintenance.
- Radiator not included.

G2, G2L

715001930

\$660.99



OUTLANDER SNORKEL KIT

- Comprehensive kit.
- Extended air intakes and CVT exhaust.
- CVT outlet integrates into pod cover.
- Must be installed on a vehicle without XT Handlebar Protector Kit.
- Ideal for muddy conditions.
- For 6x6, appropriate gauge support is required for best fit and finish.
- Not compatible with windshields.

G2 2015 & up, G2L (except X mr)

715005999

\$688.00

G2 (2012-2014 only)

715001730

\$633.00

**G2 (X mr models only),
G2L (X mr models only)**

- Raised horn only.
- Provides higher intake.
- For best fit and finish, appropriate gauge support is required.

715002518

\$162.99



**EXPERT
CHOICE**

Factory-design
fit-and-finish
for outstanding
deep mud and
water fording
performance.

New SELF-CLEARING FOOTWELLS

- Made from aluminum.
- Replace original footwells.
- Feature large evacuation ports to avoid mud and snow accumulation in footwells.
- Aggressive design for improved traction.
- Not compatible with Body Side Protectors.
- Sold in pairs.

G2 2015 & up, G2L

715004759

\$452.99

**EXPERT
CHOICE**

Aids in rider traction
and clears heavy
mud and snow
debris with ease.



X MR TRACTION PLATES

- Provide extra foot grip for driver when riding in extreme mud conditions.
- Help driver maintain ideal riding position to maximize vehicle traction.
- Made of aluminum.
- Not meant for a passenger.

G2, G2L (MAX models only)

715001752

\$180.99



FOOTPEG KIT

- Provides maximum integrated grip and more stability during vigorous riding.
- Kick-up end generates added grip during hard cornering.
- Made of aluminum.
- Sold in pairs.

G2, G2L

715001131

\$81.99





BELIEVE IT: YOUR RENEGADE IS A FEW MODS AWAY FROM BEING A TRUE MUD-READY BEAST

- RENEGADE SNORKEL KIT
- RENEGADE RADIATOR RELOCATOR KIT
- MUD STRAP

RENEGADE

RENEGADE SNORKEL KIT

- Comprehensive kit.
- Extended air intakes and CVT exhaust.
- CVT outlet integrates into pod cover.
- Ideal for muddy conditions.

G2S

715006000
\$801.99



ADAPTER KIT

- (Not illustrated)
- Necessary to install the G2S Snorkel Kit (715001928) on 2012 to 2014 models.

G2S (for 2012-2014 models only)

715003122
\$81.99

RENEGADE RADIATOR RELOCATOR KIT

- Relocates radiator to top mount position.
- Prevents cooling performance loss in muddy conditions.
- Uses existing radiator.
- Includes support, hardware and hoses.
- Engineered for easy cooling system bleeding and maintenance.
- Radiator not included.
- Renegade Extreme Front Bumper (715002469) required for installation (except X mr).

G2S

715001929
\$688.00



OUTLANDER | RENEGADE

MUD STRAP

- Convenient sturdy grab-handle.
- Lets drivers redistribute their weight for improved traction in demanding conditions.
- Not compatible with XT Handelbar Protector Kit (703100352).

G2, G2L, G2S

715003053
\$72.99



RADIATOR PROTECTOR

- Metal shield that mounts over radiator face, providing protection from stones and branches.

G2, G2S (except G2S with 500 engine)

715001744
\$108.99

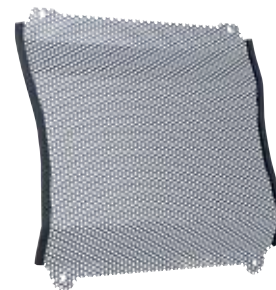

YOSHIMURA
EXHAUST MADE IN THE USA FOR
can-am

**YOSHIMURA
GIVES YOU THE
EDGE WITH MORE
PERFORMANCE
& LESS WEIGHT**

YOSHIMURA SLIP-ON EXHAUST

- Made from 304-grade stainless steel.
- Better sounding, better looking and lighter than stock muffler.
- USDF/USDA approved spark arrester.
- NON EPA compliant (for racing application only).
- Not EC compliant.
- Fuel injection system tuning not required.
- Not compatible with CARB, NRMM & T Category models 2018 and up.

OUTLANDER

G2 2018 & prior (except 6x6 models)

715005482

\$747.99

G2 2019 & up (except 6x6 models)

715005480

\$777.99



RENEGADE

G2S 2018 & prior (except 570 engine and X mr models)

715005483

\$921.99

G2S 2019 & up (except 570 engine and X mr models)

715005481

\$958.99



**EXPERT
CHOICE**

Sound, engineering, and style: This exclusive slip-on Yoshimura exhaust roars like no other.

OUTLANDER | RENEGADE



FOX SHOCKS

- Engineered for the more aggressive riders.
- Offer increased bump absorption and better roll control.
- Offer a slightly firmer ride than standard kits but remain very versatile for all-around use.
- Kit includes 4 shocks and springs.
- Rebuildable.
- Threaded preload adjusters.

G2 2012-2018 (except X mr, XT-P, Limited & 6x6 models), G2 X mr 650 (2012-2018), G2S (Base model with 500 & 570 only), G2L & G2L MAX

715001471

\$1,000.99

G2, G2S 2019

715005469

\$1,175.99



FOX PERFORMANCE SHOCKS 1.5 PODIUM X RC2 HPG

- High-performance front and rear shocks.
- Allow handling to readily adapt to terrain and riding style.
- Easy-adjust dual-speed compression, rebound and preload settings.
- Standard on G2S X xc.

G2 2012-2018 (except X mr, Limited & 6x6), G2 X mr 650 & G2S (Base model & X mr 570 only)

715003201

\$3,586.99

G2 2019

715005470

\$3,617.99



FRONT SHOCK COVERS

- Feature ventilation holes.
- Offer added protection in rough terrain and weather conditions.
- Sold in pairs.

G2, G2L, G2S

715500301

\$63.00



HEAVY-DUTY SPRINGS

- Heavy-duty springs provide enhanced stiffness.
- Perfect for snow clearing and hauling heavy loads.
- Improves handling and helps prevent accidental overturns.
- Sold in pairs.
- Standard on Outlander Pro and Mossy Oak models.

Front

G2 2012-2018 (Base model, DPS, XT, X mr with 650 engine only & Limited), G2S (Base model with 500 & 570 engines only)

715003199

\$176.99

Rear

G2 2012-2018 (Base model, DPS, XT & X mr with 650 engine only),

G2S (Base model with 500 & 570 engines only)

715003200

\$176.99

Front & Rear

G2 2019 (Base, DPS & XT models)

715005159 **New**

\$506.99



Front

Rear

FOAM AIR FILTER BY TWINAIR®

- Maximizes performance by increasing air flow throughout RPM range.
- Maintenance-friendly, i.e. just wash, re-oil and re-use after riding in severely dusty/muddy environments.

G2, G2S, G2L

715001333

\$95.99



EMERGENCY KIT

- Complete emergency kit provides all essential equipment and supplies to get out of most unfavorable situations powersport enthusiasts can find themselves in.
- Includes: Jumper Cables, Air Compressor, Tire Repair Kit, Ratchet Tie-Down, Duct Tape, Tow Strap 3,300 lb (1,500 kg), Zip-Ties, Cloth Rags.

715004359

\$226.99



PERFORMANCE

ACCESSORIES

OUTLANDER | RENEGADE

TRAILERING COVERS

- Heavy-duty canvas made of UV-resistant solution-dyed polyester.
- Protect windshield and colored panels from abrasion.
- All high-abrasion areas are reinforced with a double canvas layer.
- Opening for fuel cap access.
- Weather-resistant trailering cover protects your vehicle during transportation.
- Quick and easy installation.
- Designed to perfectly fit your vehicle with or without Can-Am accessories.

G2 (except MAX models)	G2 (MAX models only)	G2L (except MAX models)	G2L (MAX models only)	G2S (except Xmr models)
715001737	715001736	715002026	715002025	715000683
\$352.99	\$380.00	\$352.99	\$394.99	\$320.99



STORAGE COVERS

- Weather-resistant storage covers.
- For vehicle storage only.
- UV-resistant solution-dyed polyester construction.
- Quick and easy installation.
- Designed to perfectly fit your vehicle with or without Can-Am accessories.

G2, G2L, G2 Xmr (except 1000), G2L Xmr, G2S, G2S Xmr	G2, G2L (MAX models only)	G2, G2L (except MAX models)	G2 MAX, G2Xmr 1000, G2L MAX
715001720	715001668	715001597 • Mossy Oak Break-Up Country Camo	715001735 • Mossy Oak Break-Up Country Camo
\$254.99	\$268.99	\$380.00	\$397.99



BOLT-ON[†] RETRACTABLE RATCHETING TIE-DOWNS

- Perfect for transporting your powersport vehicle or securing loads.
- Mounts easily: Bolts on any flat surface (e.g. truck bed or frame).
- 1" x 6' (2.5 cm x 1.8 m) tie-down strap with heavy-duty stitching that delivers a 500 lb (226 kg) working load strength and 1,500 lb (680 kg) break strength.
- Convenient retractable push button automatically slackens, spools and stores away strap, while the ratchet mechanism tightens the strap snugly to secure your vehicle or load into place.
- Rubber ratcheting handle provides firm grip, and the hook is vinyl coated to protect whatever surface it hooks into.
- Sold in pairs.

295100737
\$51.99



RATCHET TIE-DOWNS

- 400 lb (181 kg) safe working load.
- 1" x 10' (2.5 cm x 3 m) strap with Can-Am, Sea-Doo, and Ski-Doo logos.
- Deluxe ratchet with rubber handle.
- Coated S hooks.
- Pack of 2.

860200447 • Black/Grey
\$29.55



FLAG

- Make sure everyone knows what you're riding.
- Perfect for the dunes and new riders.
- 8-foot (2.4 m) length.
- Includes flag mount (715000127).

715000277 • Yellow
\$43.99

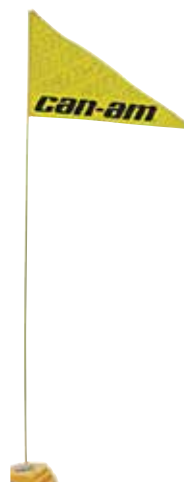

FLAG MOUNT

715000127
\$28.42

LOCKABLE GAS TANK CAP

- Protects your fuel.
- Meets EPA requirements.

G2, G2L, G2S
860200387
\$58.99



LICENSE PLATE BRACKET

- Provides specific area to install license plate.
- Mounts to rear of vehicle.

G2L
715002498
\$36.99

G2S
715001401
\$36.99



DECAL

• 6" x 12 3/4" (15 cm x 32 cm).
704901483
\$25.30



STORAGE COVER

- (Not illustrated)
- For storage use only.
 - Heavy-duty elastic cord around bottom for secure fit.
 - 100-denier polyester construction.
 - Fits with or without windshield and mirrors.

G2 (6x6 models only)
715002492
\$452.99

APACHE

TRACK SYSTEMS

Each track has a specific purpose and is designed without compromise for work and play. Whether it's for deep snow riding, trail riding or for heavy loads, Apache tracks are akin to floating across the terrain.

TRACK SYSTEMS

ACCESSORIES

WINTER TRACKS

SNOW

YEAR ROUND TRACKS

**MIXED
CONDITIONS**

APACHE BACKCOUNTRY

Finally explore winter with no traction limitations and no compromise, thanks to the unmatched performance of Apache Backcountry track kits. Engineered to thrive in the deepest snow—for work or play. Don't let winter stand in the way.

P.50

APACHE 360, 360 LT

These track kits improve your vehicle's ground clearance and increase its contact patch with the terrain. Adapt your track setup to the conditions you'll be riding in and the purpose of your ride, with the Apache 360 and 360 LT systems: as our all-season, all-terrain masterpieces.

P.51-52

WINTER TRACKS

GET THE MOST OUT OF YOUR CAN-AM ATV THIS WINTER FOR ALL YOUR ENDEAVORS.

Explore without compromise. Ride on untouched trails, traveling deep into winter's embrace and you'll know: The same technology behind our world-renowned snowmobiles is at your command. With a larger contact patch, and more aggressive track design, travel beyond what you thought possible with the best snow performance.

COVERED BY A 1-YEAR WARRANTY

OUTLANDER | RENEGADE

APACHE BACKCOUNTRY

EFFICIENT FRAME AND RAIL DESIGN ENSURES WEIGHT IS EVENLY DISTRIBUTED ON SNOW

LARGEST CONTACT PATCH ANYWHERE:
23% MORE THAN THE APACHE 360 LT



EASY-TO-OPERATE SNOWMOBILE-TYPE SLIDING TENSIONER

APACHE BACKCOUNTRY TRACK SYSTEM

- Designed to deliver the best flotation level and deep-snow performance on the market.
- Contact patch is 23% bigger than the Apache 360 LT.
- Impressive added ground clearance of 7" (18 cm), keeps the vehicle out of deep snow.
- Aggressive track design with 2" (5 cm) lug height for maximum traction on snow.
- Apache Backcountry Mounting Kit and engine and CVT air intake pre-filters are required.
- For winter use only.

G2 (except 6x6 models), G2S, G2L
715003042

IDLER WHEEL KIT

- Reduces drag and rolling resistance.
- Includes 2 wheels, brackets and hardware.
- Add up to 2 kits per rear track.
- Can extend slider life in hardened snow conditions.

Apache Backcountry Track System
(rear tracks only)

860201230 • 141 mm



SLIDERS WITH VESPEL[†] INSERTS

- Use DuPont Vespel inserts for less friction.
- Longer life.
- Can be cut to desired length.
- 8 needed per vehicle.
- Sold individually.

Apache Backcountry Track System
503194815



RAIL ICE SCRATCHERS

- Provide additional lubrication in hard and icy conditions.
- Rail mounted, small, light.
- Design expands on coil concept to allow reversing without damage.
- Easily stored when not in use.

Apache Backcountry Track System
860201728



YEAR ROUND TRACKS

WORK & PLAY YEAR ROUND THROUGH MUD, SNOW, & ALL TYPES OF TERRAIN.

Rise above terrain, weather, and whole seasons with the Apache 360, 360 LT and 360 LT 6x6 track kits — the upgrade that takes the Can-Am experience to another level. Designed for superior traction and carrying heavier loads in soft terrain, they can be used with your ATV year round for exploring and completing tough tasks.

COVERED BY A **2-YEAR WARRANTY**



OUTLANDER | RENEGADE

APACHE 360 & 360 LT

ADDED GROUND CLEARANCE OF 4.5" (11.4 CM)

APACHE 360

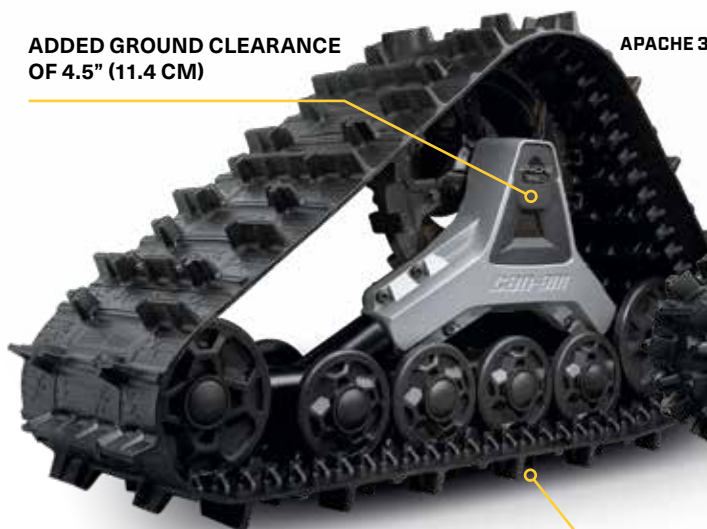

APACHE 360 LT



TOTAL GROUND SURFACE AREA: 2,079.7 IN² (13,417 CM²)

UNIQUE ADJUSTABLE CONTACT PATCH SYSTEM TO TACKLE THE TOUGHEST YEAR-ROUND CONDITIONS



RUBBER OVER MOLDED HEAVY-DUTY DOUBLE BEARING WHEELS AND OFFSET WHEEL SPACING REDUCE FRICTION AND VIBRATION WHILE ENSURING RELIABILITY

GROUND SURFACE AREA IS 7 TO 9% LARGER THAN THE APACHE 360's

APACHE 360 TRACK SYSTEM

- Multifunctional tracks perfect for any Can-Am ATV.
- Average ground clearance of 16" (41 cm).
- 1" (2.5 cm) lugs in the front and 1.25" (3.2 cm) in the back.
- Apache 360 & 360 LT Mounting Kit and engine and CVT air intake pre-filters are required.

G2 (except 6x6 models), G2L, G2S

715005240

APACHE 360 LT TRACK SYSTEM

- Multifunctional tracks designed to support heavy loads and to fit on most Can-Am off-road vehicles.
- Front wheel height adjustment provides enhanced attack angle and better performance over rough terrain when raised or increased contact patch for improved flotation when lowered.
- Average ground clearance increase of 4.5" (11.4 cm).
- 1" (2.5 cm) lugs in the front and 1.25" (3.2 cm) in the back.

G2, G2S, G2L

715005103

- Apache 360 LT Mounting Kit, Track DPS Module and Engine & CVT Pre-Filter Kit are required.
- Reliable heavy-duty build.
- EC compliant.
- Contact patch is 7 to 9% bigger than the Apache 360's.
- Apache 360 & 360 LT Mounting Kit, Track DPS Module and engine and CVT air intake pre-filters are required.



OUTLANDER 6X6

APACHE 360 LT 6X6

ADDED GROUND CLEARANCE OF 4.5" (11.4 CM)



UNIQUE ADJUSTABLE CONTACT PATCH SYSTEM TO TACKLE THE TOUGHEST YEAR-ROUND CONDITIONS



RUBBER OVER MOLDED HEAVY-DUTY DOUBLE BEARING WHEELS AND OFFSET WHEEL SPACING REDUCE FRICTION AND VIBRATION WHILE ENSURING RELIABILITY

APACHE 360 LT (6X6) TRACK SYSTEM

- Multifunctional tracks designed to support heavy loads and to fit on most Can-Am off-road vehicles.
- Front wheel height adjustment provides enhanced attack angle and better performance over rough terrain when raised or increased contact patch for improved flotation when lowered.

- Average ground clearance increase of 4.5" (11.4 cm).
- 1" (2.5 cm) lugs in the front and 1.25" (3.2 cm) in the back.
- Apache 360 LT Mounting Kit, Track DPS Module and Engine & CVT Pre-Filter Kit are required.
- Reliable heavy-duty build.
- EC compliant.

- Exclusively for the Outlander 6x6.
- Recommended for use on snow only.

G2, G2L (6x6 only)
715005104

ATV TRACK SYSTEM FITTING GUIDE

Track Kit	Vehicle	Mounting Kit	DPS Module	Pre-Filter
APACHE BACKCOUNTRY 715003042	G2, G2S 2018 & prior & G2L	715004830	715005243	Air Intake Pre-Filter 715004729 + CVT Air Intake Pre-Filter 715003483 <i>Standard on G2 models and G2L PRO model</i>
	G2, G2S 2019 & up	715004796	Models with Intelligent Throttle Control (iTC™): 715004707 Everything else: 715005243	
APACHE 360 715005240	G2, G2S 2018 & prior & G2L	715004829	715005243	
	G2, G2S 2019 & up	715004795	Models with Intelligent Throttle Control (iTC™): 715004707 Everything else: 715005243	
APACHE 360 LT 715005103	G2, G2S 2018 & prior & G2L	715004829 + 715003063 (adaptor)	715005243	
		G2, G2S 2019 & up	715004795 + 715003063 (adaptor)	Models with Intelligent Throttle Control (iTC™): 715004707 Everything else: 715005243
APACHE 360 LT 6X6 715005104	G2 2018 & prior, G2L (6x6 models)	715004991	Models with Intelligent Throttle Control (iTC™): 715004707 Everything else: 715005243	
	G2 6x6 models 2019 & up	715005105		

APACHE BACKCOUNTRY MOUNTING KIT

(Not illustrated)

- Required for installation of the Apache Backcountry Track System.
- DPS module and pre-filter are required and sold separately.

G2 2018 & prior, G2S 2018 & prior, G2L

715004830

G2 2019, G2S 2019

715004796

APACHE 360 & 360 LT MOUNTING KIT

(Not illustrated)

- Required to install Apache 360 & 360 LT Track Systems.
- Requires Apache 360 LT ATV Adapter (715003063) for installation of the Apache 360 LT Track System.
- DPS module and pre-filter not included.

G2 2018 & prior (except 6x6 models),

G2S 2018 & prior, G2L

715004829

G2 2018 & prior,

G2L (6x6 models)

715004991

G2 2019 (except 6x6 models),

G2S 2019

715004795

G2 6x6 models 2019 & up

715005105

APACHE 360 LT ADAPTOR

(Not illustrated)

- Required to install an Apache 360 LT Track System.
- Apache 360 and 360 LT Mounting Kit also required.

G2 (except 6x6 models), G2S, G2L

715003063

TRACK DPS MODULE

(Not illustrated)

- An innovative DPS module that ensures speedometer accuracy and optimized steering assist, which make for perfect track control and riding ease.
- Required to install the Apache Track Systems.

Models without Intelligent Throttle Control (iTC™)

715005243

Models with Intelligent Throttle Control (iTC)

715004707

ENGINE AIR INTAKE PRE-FILTER

- Adds extra protection to your engine in harsh riding conditions.
- Filter blocks particles larger than 0.005" (0.13 mm).
- Necessary to maintain vehicle warranty when tracks are installed.

G2, G2L, G2S

715004729



CVT AIR INTAKE PRE-FILTER

- Adds extra protection to your engine in harsh riding conditions.
- Filter blocks particles larger than 0.007" (0.19 mm).
- Easy, tool-less installation.
- Necessary to maintain vehicle warranty when tracks are installed.
- Required to install the Apache and Backcountry Track Systems.
- Standard on Outlander 650, 850, 1000, 1000R engines and G2L PRO.

715003483



New SELF-CLEARING FOOTWELLS

- Made from aluminum.
- Replace original footwells.
- Feature large evacuation ports to avoid mud and snow accumulation in footwells.
- Aggressive design for improved traction.
- Not compatible with Body Side Protectors.
- Sold in pairs.

G2 2015 & up, G2L

715004759



Aids in rider traction and clears heavy mud and snow debris with ease.

PROMOUNT — PLOWS



FIT & COMPATIBILITY



QUALITY & RELIABILITY



STYLE & VISION

The new ProMount lineup was created for both professional operators and enthusiasts looking to take their tool kit to the next level. Designed to work as efficiently as possible, Can-Am reimagined the plow from mount to blade.



Underbelly mounting plate provides the optimal angle of attack for best push strength.

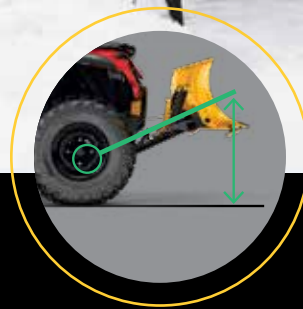

The forward mounted push frame provides industry leading lift height.



Low profile mounting plate has little impact on ground clearance and can be left installed year round.

MOST EFFICIENT MOUNTING SYSTEM

CONNECTS WITH A CLICK

Attachable in **FOUR EASY STEPS**, the Can-Am ProMount plow system is the fastest, easiest way to start plowing and get the job done—minimal effort for maximum result.



1
Drive straight toward the plow.



2
Attach the winch cable to the plow using a guiding hook/roller.



3
Lift the plow until it clips onto the mounting plate.



4
Remove the winch cable from the guide. You're ready to plow.

OUTLANDER | RENEGADE

CAN-AM PROMOUNT STEEL PLOWS

Consult your dealer for the best plow width. Made from 12-gauge steel and designed for efficient plowing, the ProMount steel blades are offered in multiple sizes to fit jobs large or small.

CAN-AM PROMOUNT STEEL PLOW KITS

These kits include:

- Can-Am ProMount Steel Blade
- Push Frame with Quick-Attach System
- Mounting Plate

54" [137 CM] BLADE

G2, G2L, G2S

- 715004339 • Black
- 715004338 • Yellow

60" [152 CM] BLADE

G2, G2L, G2S

- 715004202 • Black
- 715004338 • Yellow

66" [168 CM] BLADE

G2, G2L, G2S

- 715004473 • Black
- 715004339 • Yellow

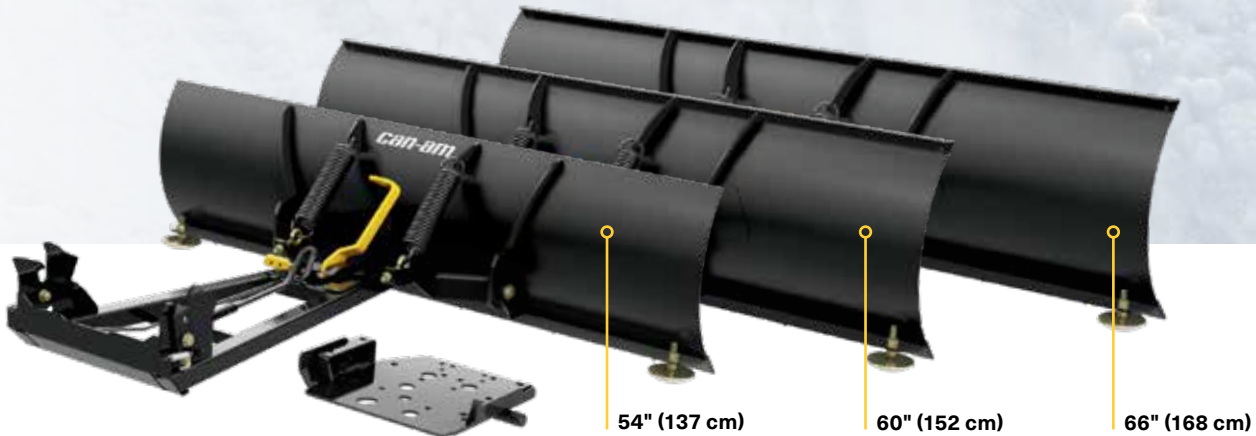

CAN-AM PROMOUNT STEEL BLADES

- Blades available individually to create your own kit.
- Compatible with Can-Am ProMount Blade accessories to further enhance plow versatility (some plow accessories are not compatible with 54" (137 cm) plows).

54" [137 CM] BLADE

- Not compatible with ProMount Drift Cutters, Blade Extensions and Edge Markers.
- Clears 50" (127 cm) when plow is fully angled.
- Blade height of 14.75" (37 cm).

Fits ProMount Push Frame

- 715004472 • Black
- 715005316 • Yellow

60" [152 CM] BLADE

- Clears 54" (137 cm) when plow is fully angled.
- Blade height of 17" (43 cm).

Fits ProMount Push Frame

- 715004202 • Black
- 715005317 • Yellow

66" [168 CM] BLADE

- Clears 60" (152 cm) when plow is fully angled.
- Blade height of 17" (43 cm).

AVAILABLE IN AUGUST 2019
Fits ProMount Push Frame

- 715006337 • Black
- 715006338 • Yellow

New

72" [183 CM] BLADE

- Clears 66" (168 cm) when plow is fully angled.
- Blade height of 17" (43 cm).

AVAILABLE IN AUGUST 2019
Fits ProMount Push Frame

- 715004474 • Black
- 715006021 • Yellow



by choosing any plow type/length that you'd like for your push frame. **ProMount Push Frames are compatible with all the blades.**

OUTLANDER | RENEGADE**CAN-AM PROMOUNT FLEX2 PLOWS**

HMWPE (High Molecular Weight Polyethylene) technology gives Flex2 greater reliability, resistance to impact, and immunity to rust or deformation. Tough on jobs but flexible in the face of obstacles, the Flex2 blade simplifies work.

CAN-AM PROMOUNT FLEX2 PLOW KIT**This kit includes:**

- Can-Am ProMount Flex2 Blade
- Push Frame with Quick-Attach System
- Mounting Plate

60" (152 CM) BLADE**G2, G2L, G2S**

■ 715004203 • Black



60" (152 cm)

CAN-AM PROMOUNT FLEX2 BLADES

- Blades available individually to create your own kit.
- Compatible with Can-Am ProMount Blade accessories to further enhance plow versatility.

60" (152 CM) BLADE

- Clears 54" (137 cm) when plow is fully angled.

Fits ProMount Push Frame

■ 715004203 • Black

New 72" (183 CM) BLADE

- Clears 66" (168 cm) when plow is fully angled.

AVAILABLE IN AUGUST 2019**Fits ProMount Push Frame**

■ 715004485 • Black



60" (152 cm)

72" (183 cm)

**CREATE
YOUR
OWN KIT**

by choosing any plow type/length that you'd like for your push frame. **ProMount Push Frames are compatible with all the blades.**



YOUR JOB, YOUR CHOICE

Get a custom solution that truly fits the task at hand—with quality components and no cut corners. The ProMount push frame, mounting plate and blades are a universal system that can be adapted to your specific Can-Am and jobsite.

OUTLANDER | RENEGADE

CAN-AM PROMOUNT PUSH FRAME WITH QUICK-ATTACH SYSTEM

- Heavy-duty steel tubes designed to withstand the roughest use.
- Mid-mount carriage provides ultimate push strength and traction.
- Designed for maximum plow lift height.
- Features a self-aligning quick-attach system, an easy foot release pedal and an ergonomic handle for plow angle adjustment.
- Plow Roller Fairlead and Plow Limit Switch recommended to extend winch cable lifespan.
- Can-Am ProMount Mounting Plate required for installation.
- Blade swivels left or right, 5 positions.
- Large pin designed for easy blade rotation to eliminate dirt and snow buildup at pivot point.

G2, G2L, G2S

715004339



Compatible
with all
ProMount
plows

CAN-AM PROMOUNT PUSH FRAME EXTENSION

- 12" (30 cm) push frame extension.

G2, G2L, G2S

715004204

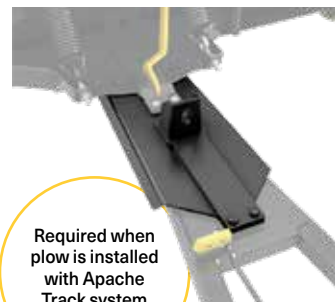

Required when
plow is installed
with Apache
Track system

CAN-AM PROMOUNT MOUNTING PLATE

- Required to install the Can-Am ProMount Push Frame with Quick-Attach System.
- Mounting plate precision-designed to stay on year round without compromising ground clearance.
- Fits on ATVs, Maverick Trail or Maverick Sport with or without Can-Am Skid Plates.

G2, G2L, G2S

715004338



OUTLANDER | RENEGADE**CAN-AM PROMOUNT PLOW ACCESSORIES****CAN-AM PROMOUNT EDGE MARKERS**

- Help locate the edges of your plow.
- Height: 24" (60 cm).
- Sold in pairs.
- Compatible with Can-Am ProMount Steel and Flex2 Blades with or without Blade Extensions (except for the Can-Am ProMount Steel 54" (137 cm) Blades).

G2, G2L, G2S

715004206

CAN-AM PROMOUNT DRIFT CUTTERS

- Help keep snow in the plow.
- Dimensions: 17" x 13" (43.2 cm x 33 cm).
- Sold in pairs.
- Compatible with Can-Am ProMount Steel and Flex2 Blades with or without Blade Extensions (except for the Can-Am ProMount Steel 54" (137 cm) Blades).

G2, G2L, G2S

715004207

CAN-AM PROMOUNT PLASTIC WEAR BLADE

- To help prevent scratches on smooth driveways and markable surfaces.

G2, G2L, G2S

54" (137 cm)	60" (152 cm)	66" (168 cm)	72" (183 cm)
715004480	715004481	715004482	715004483

New**CAN-AM PROMOUNT BLADE EXTENSIONS**

- Add 3" (8 cm) each side.
- Compatible with Can-Am ProMount Blades (except for Can-Am ProMount Steel 54" (137 cm) Blade).
- Longer Wear Blade can be installed to further extend the extra length already provided by the extensions.
- Compatible with Can-Am ProMount Steel and Flex2 Blades (except for the Can-Am ProMount Steel 54" (137 cm) Blades).

G2, G2L, G2S

- 715004205 • Black
- 715005319 • Yellow

PLOW ROLLER FAIRLEAD

- Larger diameter lower roller reduces wear on wire rope for plow application.
- Can be used with all ProMount plows.

G2, G2L, G2S

705009222

**PULLEY KIT**

- Pulley kit to be used in conjunction with the winch when using a snow plow.
- Recommended to increase winch efficiency.
- To be used with the XT Front Bumper.

715000279

**SYNTHETIC WINCH CABLE FOR PLOWING**

- Specially designed for plowing applications.
- 8' (2.4 m) section of durable, extra-strong synthetic rope.
- Stands up to repeated, sharp angle pulls used to lift heavy plow blades.
- Temporarily replace your winch rope for plow season to save wear and tear on wire rope.

715000540

**PLOW LIMIT SWITCH**

- (Not illustrated)
- For controlling the cable tension when over raising your plow system.
- Prevents winch, plow push frame and vehicle damage.

G2, G2L, G2S

715004775

REAR TIRE CHAINS

- Improve your traction in mud and snow.
- Sold in pairs.

26" x 10" x 12"

715500218

25" x 10" x 12"**27" x 9" x 14"**

715000225



ITP TERRACROSS TIRE

- This smooth-riding tire will command every bit of traction from the ground while still managing to float across loose snow, sand and mud.
- Features extreme-duty construction for improved puncture protection, extra-tough rubber compound for increased tread life, and the interlocking tread pattern and wide footprint make it one of the toughest and grippiest radials around.
- Not EC compliant.

G2 XTP, G2 Limited

Front • 26" x 8" x 14"
705401906

Rear • 26" x 10" x 14"
705502421



GROUND-GRIPPING TRACTION MEETS LOOSE MUD MANEUVERABILITY. THE TOUGH TIRE WITH THE SMOOTH RIDE.

ITP CRYPTID TIRE

- Graduated lug height and paddle-like shoulder configuration provide maximum side bite for climbing in and out of the mud without compromising ride comfort on trails and hard pack.
- 6-ply rated.
- 30" x 9" x 14".

G2 X mr 850 & 1000R 2018 & up.
G2S X mr 1000R 2018 & up

705402178



ZILLA TIRE BY MAXXIS*

- Sold individually.

Front
27" x 10" x 14"
705401302

Rear
27" x 12" x 14"
705501703



ITP MEGA MAYHEM

- 1.5" tread depth mud thrower tires.
- Surprisingly smooth ride on hard pack surfaces.
- 6-ply rated.

G2 X mr 570 & 650 2018 & up.
G2S X mr 570 2018 & up

Front
28" x 9" x 12"
705402131

Rear
28" x 11" x 12"
705502645



CARLISLE ACT TIRE

G2 (500-1000 XT models only)

Front
26" x 8" x 12"
705401333
705401334 • (C€)

Rear
26" x 10" x 12"
705501769
705501770 • (C€)

G2 (400 XT models only)

Front
25" x 8" x 12"
705400606
705400326 • (C€)

Rear
25" x 11" x 12"
705500933
705500598 • (C€)

GORILLA SILVERBACK TIRE

- AT30X9-14 Gorilla Silverback mud tire.
- Sold individually.
- Not EC compliant.

G2 (850 & 1000 models only)

30" x 9" x 14"
705400962



CARLISLE ACT HD TIRE

Front
26" x 8" x 12"
705401736

Rear
26" x 10" x 12"
705502297



MAXXIS MUDZILLA TIRE

- Not EC compliant.

G2 (X mr 570 & 650 models only)

Front
28" x 8" x 12"
705401391

Rear
28" x 10" x 12"
705501836



CARLISLE BADLANDS A/R TIRE

G2 (500-1000 Base models only)

Front
26" x 8" x 12"
705401331
705401332 • (C€)

Rear
26" x 10" x 12"
705501767
705501768 • (C€)



*Consult your operator's guide/owner's manual for proper tire type and rim sizing. Improper tire type and rim selection may affect vehicle handling. Check with your local authorities for proper regulation.



CARLISLE TRAIL WOLF TIRE

G2 (400 Base models only)

Front 25" x 8" x 12" 705401625 705401626 · (C€)	Rear 25" x 11" x 12" 705502164 705502165 · (C€)
---	---



KENDA KLAW MXR TIRE

DS 90 X

Front - 20" x 6" x 10" V42711DGF01HLL	Rear - 18" x 10.5" x 8" V42712DGF01HLL
--	---



ITP HOLESHOT ATR TIRE

G2S

Front 205/80R12 25" x 8" x 12" 705400600 705400475 · (C€)	Rear 270/60R12 25" x 10" x 12" 705500926 705500820 · (C€)
---	---



REAR TIRE CHAINS

- Improve your traction in mud and snow.
- Sold in pairs.

26" x 10" x 12" 25" x 11" x 12" 715500218	25" x 10" x 12" 26" x 9" x 12" 27" x 9" x 14" 715000225
---	--



DURO THRASHER TIRE

DS 90/70

Front - 19" x 7" x 8"
V42711DGF000LL

Rear - 18" x 9.5" x 8"
V42712DGF010LL



KENDA KNARLY TIRE

DS 250

Front - 22" x 7" x 10"
S44710RCA000

Rear - 20" x 11" x 9"
S42710RCA000



RIMS

14" RIM

- Premium cast aluminum black painted with machining and clear coat rim.
- Center hole: 72 mm.
- Bolt circle pattern: 4/136 mm.

G2 DPS, G2 XT, G2 MAX 650, G2 MAX XT, G2 MAX Limited

Front - 14" x 6.5" offset = 40 mm 705401853 • Black and machined 705401852 • Black with clear coat 705401851 • Silver with clear coat	Rear - 14" x 8.5" offset = 50 mm 705502402 • Black and machined 705502401 • Black with clear coat 705502400 • Silver with clear coat
--	---



NOTE: Matching Nuts - 250100100 Black, 250100082 Chrome / Matching Cap - 705400928

Some products shown may not be available or homologated in your country. Contact your BRP dealer for local details.

14" RIM**G2 DPS, G2 XT, G2 MAX Limited, G2 North Edition, G2 MAX North Edition**

Front - 14" x 6.5" offset = 40 mm

Rear - 14" x 8.5" offset = 50 mm

705402309 • Black and machined
 705402222 • Black with clear coat
 705402307 • Silver with clear coat

705502770 • Black and machined
 705502702 • Black with clear coat
 705502768 • Silver with clear coat

**OUTLANDER X MR AND DEFENDER RIM**

• Cast aluminum rim with trend setting explosive styling so you can ride - and look - like a trailblazer.

X mr models front and rear wheels

Front

14" x 6.5" offset = 10 mm

■ 705401848 • Black and machined
 ■ 705401849 • Black

**NOTE:**

Matching Nuts - 250100100 Black,
 250100082 Chrome / Matching Cap - 705401541

OUTLANDER X MR RIM - ITP-SS212*

• Black with machining and clear coat rim.
 • Sold individually.

G2 (X mr models only)

Front and Rear - 14" x 6"

705400877 • Black and machined

**NOTE:**

Matching Nuts - 250100100 /
 Matching Cap - 705400963

OUTLANDER RIM (CAMO MODEL)

• Black with clear coat aluminum rim.

G2, G2L, G2S

Front - 12" x 6" offset = 41 mm

705401127 • Black with clear coat

Rear - 12" x 7.5" offset = 51 mm

705501493 • Black with clear coat

**LOCKOUT 393 14" RIM BY VISION***

• Sold individually.

Front - 14" x 7"

Bolt circle pattern:

4/136 mm

Wheel offset: 4 + 3

705401363

Rear - 14" x 8"

Bolt circle pattern:

4/136 mm

Wheel offset: 4 + 4

705501787



NOTE: Matching Nuts - 250100100 /
 Matching Cap - 705401362

12" BEADLOCK RIM

• Black with clear coat aluminum rim.
 • Needs 16 bolts (250000435) for installing the beadlock.
 • Choice of beadlock color (not included).

G2, G2L, G2S

Front - 12" x 6" offset = 41 mm

705401678 • Black

Rear - 12" x 7.5" offset = 51 mm

705502244 • Black

**14" BEADLOCK RIM**

• Black with clear coat aluminum rim.
 • Choice of beadlock color (not included).
 • Needs 16 bolts (250000435) for installing the beadlock.

G2

Front - 14" x 6.5" offset = 41 mm

705401594

Rear - 14" x 8" offset = 51 mm

705502146

**12" BEADLOCK**

• Cast aluminum beadlock.
 • Must be installed on Front Rim (705401678) and Rear Rim (705502244).

G2, G2L, G2S

■ 705401763 • Can-Am Red

■ 705401811 • Orange Crush

■ 705401812 • Manta Green

■ 705401810 • Yellow

14" BEADLOCK

• Cast aluminum beadlock.
 • Must be installed on Front Rim (705401594) and Rear Rim (705502146).

G2

■ 705401586 • Manta Green

■ 705401702 • Octane Blue

■ 705401840 • Black

■ 705401837 • Can-Am Red

NOTE: Matching Nuts - 250100100 /
 Matching Cap 705400928

NOTE: Matching Nuts - 250100100 /
 Matching Cap 705400928

*Consult your operator's guide/owner's manual for proper tire type and rim sizing. Improper tire type and rim selection may affect vehicle handling. Check with your local authorities for proper regulation.



RIDING GEAR



CAN-AM OFF-ROAD RIDING GEAR LIMITED WARRANTY*

1-YEAR LIMITED WARRANTY ON SPORTSWEAR AND RIDING GEAR**

4-YEAR LIMITED WARRANTY ON HELMETS**

*Purchased at an authorized BRP dealership / distributor. Other exclusions may apply, see complete limited warranty or contact your Can-Am off-road authorized dealer.
**Unless otherwise stipulated or required by law.





RIDING WITH STYLE AND PROTECTION. ROCK EVERYWHERE.





New ZIPPED HOODIE

60% Cotton,
40% Polyester Fleece

286709 • S-3XL
Heather Grey (27),
Black (90)

\$135.64

**New CAN-AM PULLOVER HOODIE**

60% Cotton,
40% Polyester Fleece

286708 • S-3XL
Khaki (05), Black (90)

\$126.60

**CAN-AM SHIRT**

60% Cotton,
40% Polyester

454074 • S-3XL
Khaki (05), Black (90)

\$117.55

**New LONG SLEEVE ORIGINAL TEE**

100% Cotton

286717 • S-3XL
White (01), Green (70)

\$63.28

**New ORIGINAL TEE**

100% Cotton

286712 • XS-3XL
Heather Grey (27),
Black (90)

\$45.20

**New X-RACE TEE**

100% Cotton

286714 • XS-3XL
White (01),
Black (90)

\$45.20

**New INTRUSION TEE**

100% Cotton

286716 • XS-3XL
Heather Grey (27),
Green (70), Black (90)

\$45.20

**New LADIES' ORIGINAL TEE**

95% Cotton, 5% Spandex

286715 • XS-2XL
White (01), Black (90)

\$45.20

**New LADIES' X RACE TEE**

95% Cotton,
5% Spandex

286713 • XS-2XL
Green (70), Black (90)

\$45.20



ADVENTURE TEAM JERSEY

- Quick-dry, antibacterial, moisture-wicking fabric.
- Extended back for coverage while riding.
- Mesh fabric for extra ventilation underarms.
- Non-fading sublimated graphics.

100% Polyester

454072 • S-3XL
Sunburst Yellow (96),
Red (30)

\$90.42**New X-RACE JERSEY**

- Ultralight, quick-dry, antibacterial and moisture-wicking fabric.
- Mesh fabric for maximum breathability.
- Extended back for coverage while riding.
- Non-fading sublimated graphics.

100% Polyester

286710 • S-3XL
Orange (12), Green (70)

\$90.42**New LADIES' TEAM JERSEY**

- Semi-fitted cut specifically designed for ladies.
- Quick-dry, antibacterial, moisture-wicking fabric for maximum comfort.
- Mesh fabric for extra ventilation underarms.
- Non-fading sublimated graphics.

90% Polyester, 10% Spandex

286711 • XS-2XL
Orange (12), Green (70)

\$90.42**New ORIGINAL CAP**

- Plastic adjustment strap at back.

100% Cotton

286707 • One size • Khaki (05), Black (90)

\$45.20**New CLASSIC CAP**

- Plastic adjustment strap at back.

100% Cotton

447702 • One size • Charcoal Grey (09), Black (90)

\$45.20**New X RACE CAP**

- Mesh at back.
- Plastic adjustment strap at back.

55% Cotton, 45% Polyester

286705 • One size • Orange (12), Green (70), Black (90)

\$45.20**New INTRUSION FLAT CAP**

- Mesh at back.
- Plastic adjustment strap at back.

100% Cotton

286706 • One size • Black (90)

\$45.20**MUD GEAR****MUD JACKET**

- 100% waterproof PVC.
- Electronically-welded seams.
- Underarm and rear vent panels.
- 2 hand pockets.
- Elastic cuffs.
- Drawstring hood and hem.

Polyvinyl Chloride (PVC)

286676 • S-2XL
Clear (00), Matte Black (93)

\$54.24**MUD PANTS**

- Oversized pants made of 100% waterproof PVC.
- Electronically-welded seams.
- Strategically placed ventilation.
- Side openings at bottom leg.

Polyvinyl Chloride (PVC)

286128 • S-2XL
Clear (00), Matte Black (93)

\$27.12



ENDURO

Designed for long rides and high adventure.

FEATURES & BENEFITS

- Offers the dual experience of riding with a visor helmet plus the look and advantages of an MX helmet.
- Advanced plastic composite shell.
- Lockable, multi-positions and anti-scratch visor.
- Interchangeable retractable sun visor.
- Removable aerodynamic peak.
- Ultra-comfort and washable Dri-Lex⁺ linings.
- Oversized and vented chin deflector.
- Adjustable air vents and exhausts.

EX-2 ENDURO HELMET

Shell: Polycarbonate Composite
448466 • XS-2XL • Black with graphics (94)

DOT ECE22.05

\$361.74



XP-3

Superlight cross-style helmet: Feature-packed for exceptional performance, protection and comfort.

FEATURES & BENEFITS

- 4-year limited warranty.
- Weight: ±1380 grams for size Large.
- Premium shell construction using superlight fiberglass and impact absorbing EPS liner.
- Aero-tuned fully adjustable visor system.
- Custom stainless grill design.
- Front and rear hi-max air vent system to maximize cooling.
- Removable, washable and replaceable CoolMax[™] moisture-wicking liner.
- Lightweight double-D chin strap.
- Triple certified: DOT, ECE and SNELL M2015.

New XP-3 PRO CROSS X-RACE HELMET

Shell: Fiberglass
448612 • XS-2XL
Charcoal Grey (07),
Green (70)

DOT Snell ECE22.05

\$434.08



Some products shown may not be available or homologated in your country. Contact your BRP dealer for local details.



XC-4

Motocross style that combines lightweight construction, comfort and features beyond its price range. Value you can't ignore.

FEATURES & BENEFITS

- 4-year limited warranty
- Weight: ±1420 g for size Large.
- Front and rear hi-max air vent system to maximize cooling effect.
- Shell construction is superlight polycarbonate with impact absorbing liner.
- Fully adjustable visor system.
- Removable, washable and replaceable moisture-wicking liner.
- Winter breath deflector (sold separately).
- Lightweight double-D chin strap.

New XC-4 CROSS TEAM HELMET

- Durable multi-colored clear coated graphics.
- Can-Am branded.

Shell: Polycarbonate Composite

448608 • XS-2XL
Charcoal Grey (07), Red (30)

DOT ECE22.05

\$271.29



DUST MASKS

- Easily replaceable filters remove 99.9% of airborne dust, particles, pollen and odors.
- Made from soft yet durable neoprene material that fits snugly under helmets and goggles.
- XS/S fits most kids 12 and under, M/L fits most riders and XL/2XL fits larger frames (235+ lbs).
- Includes 2 replacement filters and a small storing pouch.
- Replacement filter (447719) available.

CAN-AM ORIGIN DUST MASK

448524 • XS/S, M/L, XL/2XL • Black with graphics (94)
\$63.28



CAN-AM VENTED DUST MASK

448525 • XS/S, M/L, XL/2XL • Black (90)
\$66.90



COMMUNICATION SYSTEM

SENA 30K BLUETOOTH COMM SYSTEM

- Bluetooth headset that operates on Sena's Mesh Intercom™ technology.
- The 30K has a new quick charge feature meaning just 20 minutes of charging gets riders an impressive 5 hours of Bluetooth intercom use, or 3 hours Mesh Intercom use.
- 2.4 GHz frequency, connecting to other riders in an entirely new way.
- Should one of the group's riders go out of range, the Mesh Intercom intelligently keeps the rest of the group in seamless communication, while actively searching to reconnect, should that rider come back within range.
- Using the private group mode, the 30K can pair in full duplex communication with up to 16 riders at a range up of to 1.2 miles (2 km).
- Sena 30K Audio Multitasking technology allows you to have a conversation via Adaptive Mesh-Networking technology while simultaneously enjoying Bluetooth operations such as streaming smartphone music, taking or making phone calls, or listening to turn-by-turn GPS navigation.

SINGLE PACK

448610 • One size • Black (90)
\$398.99

DUAL PACK

448611 • One size • Black (90)
\$699.00



*Some models and accessories shown may not be available or homologated in your country. Contact your BRP dealer or local authorities for information.



GOGGLES

CAN-AM RACE SAND GOGGLES BY SCOTT

- Dust catcher vent foam.
- Custom painted frame and strap graphics.
- UV protected Lexan® lens with No Fog™ anti-fog lens treatment.
- Hypoallergenic multi-layer face foam.
- Durable and anti-slip full strap attachment.
- Extra clear lens in the box.
- Storing pouch included.
- Speed Strap attachment system compatible (sold separately).
- Tear-off and roll-off compatible (sold separately).

448638 • One size • Black (90)

\$142.87



CAN-AM TRAIL GOGGLES BY SCOTT

- UV protected Lexan® lens.
- Hypoallergenic super-soft face foam.
- Speed Strap attachment system compatible (sold separately).
- Durable and anti-slip full strap attachment.
- Tear-off and roll-off compatible (sold separately).

448616 • One size • White (01), Red (30), Black (90)

\$63.28



GLOVES

New X-RACE GLOVES

- Air mesh panels for ventilation and mobility.
- Double Clarino® layer at palm and thumb for extra durability and comfort.
- Pre-curved design.
- Silicone fingertip for better grip.
- Hook-and-loop wrist closure system.

Shell: Air Mesh, Spandex, Clarino®



MEN'S

286718 • XS-2XL • Orange (12), Green (70)

\$72.34



LADIES'

286719 • S-2XL • Orange (12), Pink (36)

\$72.34

ADVENTURE TEAM GLOVES

- Spandex construction for flexibility.
- Chamude palm.
- Pre-curved design.
- Slip-on gloves.
- Silicon print at inner fingers.

Shell: Spandex, Chamude, Polyester

446305 • S-3XL • Red (30)

\$48.82



JUNIOR

JUNIOR X CRUSH HELMET

- Multi-density EPS liner.
- Ultra-plush removable/washable liners.
- Adjustable visor to protect from the elements.
- Multiple air vents help keep you cool and dry.
- Lightweight double-D chin strap.
- Ski-Doo and Can-Am stickers in the box.
- Optional breath deflector (sold separately).

Shell: ABS

448506 • S, M, L • Black with graphics (94)

\$180.86



New CAN-AM BUZZ GOGGLES BY SCOTT

- UV protected Lexan® lens.
- Hypoallergenic super-soft face foam.
- Durable and anti-slip full strap attachment.
- Speed Strap attachment system compatible (sold separately).

448620 • One size • Black (90)

\$63.28



BAGS

CAN-AM CARRIER DRY BACKPACK BY OGIO

- Completely waterproof rolltop construction.
- Reflective screen print.
- Airflow back panel keeps the rider cool.
- 2-way adjustable sternum strap.
- Dual-density shoulder straps for maximum comfort.
- Removable inner liner to allow bigger storage.
- Laptop and tablet sleeves.
- Organization panel with 2 zippered pockets.
- Dimensions: 20.5" H x 10.5" W x 6.75" D (52 cm x 27 cm x 17 cm).

100% Polyester
469544 • One size • Black (90)
\$253.21



CAN-AM SLAYER GEAR BAG BY OGIO

- Large main compartment with easy access to all gear.
- Large separated boot pocket.
- Zippered accessory pocket.
- Easy grab handles for transport.
- Detachable shoulder strap.
- Heavy-duty reinforced base.
- Dimensions: 32" H x 16" W x 18" D (81 cm x 41 cm x 46 cm).

100% Polyester
469294 • One size • Black (90)
\$189.90



CAN-AM URBAN BACKPACK BY OGIO

- Airport security friendly protective laptop compartment.
- Padded iPad™/tablet/e-reader pocket.
- Dual side water bottle/accessory holders.
- Fully adjustable ergonomic shoulder straps.
- Front pocket with 2 padded accessory compartments and slip pocket.
- Dimensions: 19.5" H x 13.5" W x 9.5" D (50 cm x 34 cm x 24 cm).

100% Polyester
469293 • One size • Black (90)
\$162.77



HOW TO MEASURE

- For best results, have someone else take measurements.
- Measure body in underwear.
- Tape must be snug but not tight.
- If measurements fall between two sizes, order the larger size.

- HEAD** Around your head, from the center of the forehead, above the ears and over the natural bump at the back of the head.
- ARM LENGTH** Let the hands hang down on the side in a slightly bent position. Measure from the center of the back of your neck, along the length of your arm, to the wrist.
- CHEST/ BUST** Measure under your arms, around the fullest part of your chest.
- WAIST** Measure around your natural waistline, keeping one finger between the tape and body.
- HIPS** Across the fullest part of the seat.
- INSEAM** Without shoes, from crotch to the floor.

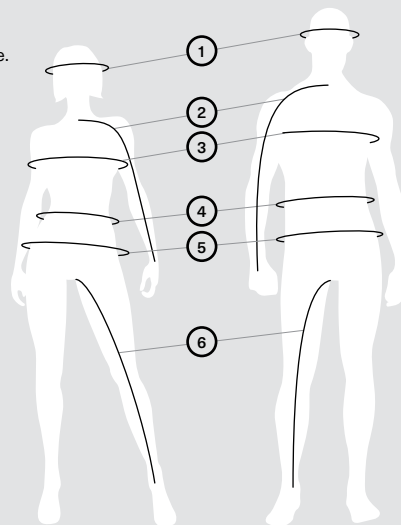

WHAT CODE REPRESENTS YOUR SIZE?

1. Find your size. 2. The corresponding code is **THE CODE** you use to complete the part number on your order.
Example: 440227__90 Size: M = Code "06", therefore 4402270690

SIZE	CODE	SIZE	CODE	SIZE	CODE	SIZE	CODE	SIZE	CODE	SIZE	CODE
One Size	00	XL	12	4XLT	19	6	25	13	33	7-8	54
XS	02	XLT	13	5XL	88	7	27	14	34	10-12	49
S	04	2XL	14	1	20	8	28	16	35	14-16	50
M	06	2XL	15	2	21	9	29	18	78	S/M	72
MT	07	3XL	16	3	22	10	30	3-4	79	M/L	91
L	09	3XLT	17	4	23	11	31	5-6	52	L/XL	73
LT	10	4XL	18	5	24	12	32	6-8	48		

RIDING GEAR & SPORTSWEAR

MEN'S-1.74 M - 1.83 M

	XS	S	M	L	XL	2XL	3XL
Chest	86-91	91-97	97-104	104-114	114-124	124-135	135-145
Waist	71-76	76-81	81-89	89-99	99-109	109-122	122-132
Hips (seat)	86-91	91-97	97-104	104-114	114-124	124-135	135-145
Arm length	76-79	79-81	81-84	84-86	86-89	89	89-91
Inseam	79-80	80-81	81	81	81	81	81

LADIES'-1.60 M - 1.77 M

	XS	S	M	L	XL	2XL	3XL
Chest	81-86	86-91	91-99	99-107	107-117	117-127	127-137
Waist	66-71	71-76	76-84	84-91	91-102	102-112	112-122
Hips (seat)	89-94	94-99	99-107	107-114	114-124	124-135	135-145
Arm length	76	76	77	79	80	81	84
Inseam	76	76	76	76	76	76	76

GLOVES (measure palm width)

MEN'S

	S	M	L	XL	2XL	3XL
Palm (cm)	8	9	10	11,5	13	14

LADIES'

	S	M	L	XL	2XL
Palm (cm)	7	8	9	10	11,5

HELMETS

MEN'S & LADIES'

	XS	S	M	L	XL	2XL	3XL
Head (cm)	53-54	55-56	57-58	59-60	61-62	63-64	65-66

JUNIOR

	S	M	L
Head (cm)	49-50	51-52	53-54

KEEP YOUR CAN-AM PERFORMING AT ITS BEST

Remember what made you fall for a Can-Am vehicle? Precisely engineered. Rigorously tested. Factory approved. The ultimate off-road experience continues with Genuine Can-Am Parts, whether installed by our trusted network of trained dealers—or Do-It-Yourself installed in the comfort of your garage.

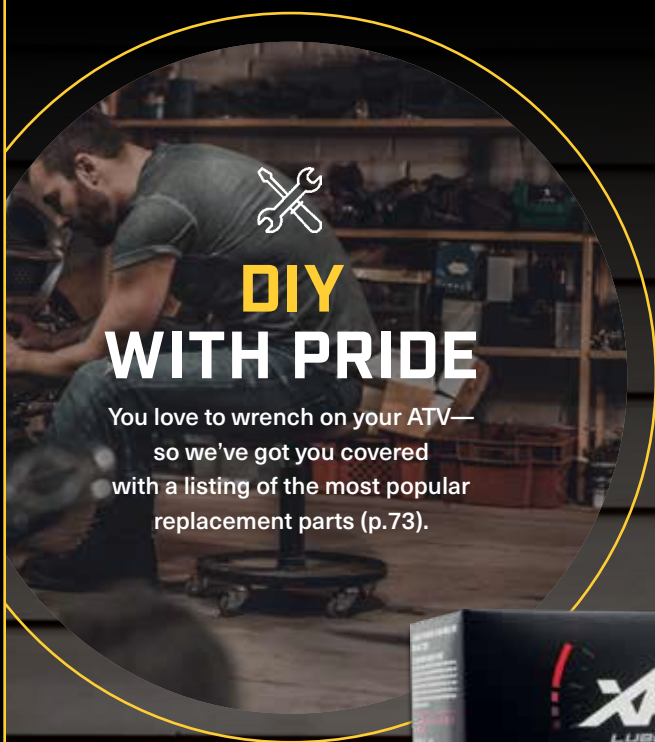

DIY WITH PRIDE

You love to wrench on your ATV—so we've got you covered with a listing of the most popular replacement parts (p.73).



*For new genuine parts sold through BRP. Includes items installed by you or authorized BRP dealer. Other exclusions may apply, see complete limited warranty or contact your Can-Am off-road authorized dealer.

ENGINE OIL CHANGE KIT

All-in-one solution that saves time and money. (p.79).



Visit the can-amoffroad.com Parts & Maintenance section to see the full line of Genuine Can-Am Parts.



REGULAR MAINTENANCE ENSURES YOUR CAN-AM ATV PERFORMS AS YOU EXPECT

KEEP AN EYE ON THESE COMPONENTS*



- ✓ **OIL FILTER** 420256188
- ✓ **ENGINE OIL** SEE P.79
- ✓ **FUEL FILTER** 709000330
- ✓ **AIR FILTER** 707800371/715001333
- ✓ **CVT AIR FILTER** 715003483/707001786
- ✓ **DRIVE BELT** 422280360/715900024
- ✓ **BRAKE PADS** SEE P.74
- ✓ **BOOT KITS** SEE P.74
- ✓ **WHEEL BEARINGS** 293350118
- ✓ **A-ARM BUSHINGS** 703500875
- ✓ **BALL JOINTS** 706202044/706202045
- ✓ **SPARK PLUG** 715900352/707000246
- ✓ **BATTERIES** 410301203/710000283

*Refer to periodic maintenance chart for proper intervals.

GENUINE CAN-AM MAINTENANCE PARTS

GENUINE CAN-AM MAINTENANCE PARTS

OIL FILTER

420256188



PERFORMANCE AIR FILTER BY TWIN AIR[†]

- The best choice for the harshest conditions.
- Multiple staged oiled filtering foam for superior dust retaining capacity with high air flow.
- Washable and reusable.

715001333

PREMIUM AIR FILTER

- The best filter on the market, it prevents airborne contaminants from reaching your engine.
- Protects internal components against premature wear.
- Genuine BRP air filters ensure absolute compatibility and a perfect fit.

707800371

O-RING [DRAIN PLUG]

(Not illustrated)

420552280

O-RING [OIL FILTER COVER]

(Not illustrated)

420230920



Complete Engine Oil Change Kit also available—See page 79.

SPARK PLUGS

715900352 • 450, 850, 1000R Engines

715900637 • 570, 650, 1000 Engine



FUEL FILTER

(Not illustrated)

709000330

CVT AIR FILTER

(Not illustrated)

715003483 • G2, G2L

707001786 • G2S

See Oil & Maintenance Products at page 77.

Note: Please contact your dealer for suggested retail prices regarding Genuine Can-Am Parts.

PARTS & MAINTENANCE

CV BOOT KITS

- Come with clamps and grease.
- Genuine BRP CV Boot Kits ensure absolute compatibility and a perfect fit.

G2, G2L, G2S**(Except X mr Models)****705401345 • Front Wheel Side****705401346 • Front Differential Side****705501864 • Rear****ATV - X mr Models****705401354 • Front Wheel Side****705401355 • Front Differential Side****705501864 • Rear****METALLIC BREAK PAD KIT**

- Built strong to last long – heavy-duty construction stands up to hard braking.
- Designed to handle demanding riding conditions with challenging braking environments such as mud and dunes.
- Created specifically for use with Can-Am vehicles.

705600350 • Front Right**705600349 • Front Left****705600398 • Rear Left****Outlander & Renegade X mr, MAX X-TP, MAX XT,****MAX PRO, MAX Limited****715900248 • Front & Rear Right****715900249 • Front Left****ORGANIC BRAKE PAD KIT**

- Chosen as the standard OEM on Can-Am ATVs for dry conditions.
- Provides excellent braking capacity with optimal efficiency, a great feel, and low noise.

G2, G2L, G2S (Except X mr Models)**705601014 • Front & Rear Right****705601015 • Front & Rear Left****PERFORMANCE DRIVE BELT (100% PBO)**

- High-performance and unique belt technology.
- 100% cutting-edge PBO high-tensile strength polymer fiber construction.
- Designed for high-temperature robustness and prolonged durability.

422280364**CTV GASKET COVER**

(Not illustrated)

G2, G2S**420430126****G2L (Outlander 450 & Outlander MAX 450)****420630292****YUASA[†] BATTERIES**

- Top of the line models from the leading preferred original equipment battery supplier in North America.

G2S, G2 & G2L**410301203 • 18 Amps. Wet • (YTX20L-BS)****DS (250, 90, 70, 50)****710000283 • 13 Amps. Wet • (YTX15L-BS)****PULLER/LOCKING TOOL**

(Not illustrated)

- Allows to spread the secondary clutch open for easy belt replacement.

529036098**PREMIUM DRIVE BELT**

- Premium drive belt calibrated to maximize your vehicle's performance.
- Aramid tensile cords used in construction for extra long life and dependability.
- Built with distinctive durability features for off-road riding.

422280360 • 500CC & More**422280280 • 450CC & Less****PREMIUM HALF SHAFT**

- Premium quality design ideal for off-road, heavy-duty and low speed torque usage.
- Includes CVs, Shaft and Boots with the best suited geometry for your Can-Am vehicle.

Please contact your dealer for suggested fitment.**PERFORMANCE HALF SHAFT**

- High-performance design ideal for off-road use with superior wheel power and acceleration for racing, dunes and desert riding.

- Includes CVs, Shaft and Boots with the best suited geometry for your Can-Am vehicle.

Please contact your dealer for suggested fitment.**A-ARM BUSHING KIT**

- This bushing kit includes 2 bushings, a sleeve and a wearplate, as illustrated. All you need to renew your suspension A-Arms.

703500875**WHEEL BEARINGS**

(Not illustrated)

- Sealed bearings for additional protection from water and dirt.

293350118**BALL JOINTS**

- Robust design for off-road usage and sealed for prolonged durability.

706202044 • Upper**706202045 • Lower**

Note: Please contact your dealer for suggested retail prices regarding Genuine Can-Am Parts.

Some products shown may not be available or homologated in your country. Contact your BRP dealer for local details.

WHAT MAKES CAN-AM BELTS STAND OUT?

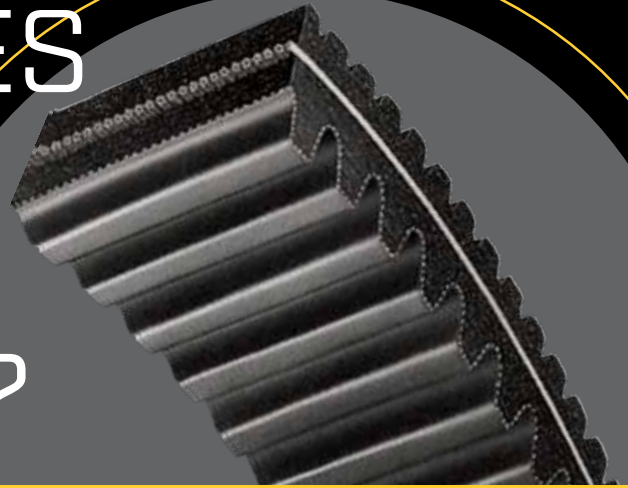

"I'VE TESTED EVERY BELT OUT THERE, AND CAN-AM'S DRIVE BELTS ARE WHAT I RELY ON TO WIN RACES."

PHIL BLURTON

2017-2018-2019 UTV World Championship Winner
2017-2018 BITD UTV Pro Production Turbo Champion



Consistent quality

We partner with the best manufacturers in the powersports industry to offer you unique drive belts with consistent quality.

Prolonged durability

The 100% cutting-edge PBO high-tensile strength polymer fiber construction offers high-temperature robustness and prolonged durability.

Tested performance

Our engineering teams have perfectly integrated and tested each drive belt to provide quick throttle response, powerful acceleration, top speed and consistent shifting performance.

Custom calibration

We aim at delivering the highest levels of performance and longevity based on your vehicle's specific end-use and calibration.

CAN-AM BELT CONSTRUCTION VS. COMPETITORS

MODULUS & TENSILE STRENGTH

Based on Dynamometer testing, PBO surpasses Kevlar and Carbon Fiber materials in every way.

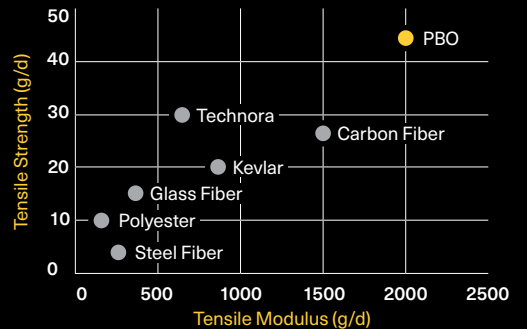

DURABILITY COMPARISON

Compared to Can-Am's Performance Drive Belt.

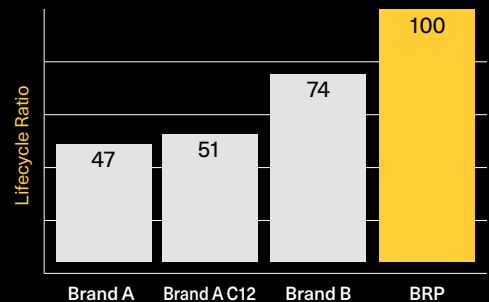

XPS

LUBRICANTS



Kyle Chaney

**2017 TORC PRO MOD UTV CHAMPION
AND MULTI-TIME GNCC CHAMPION**

Experienced short course and cross country champion racer Kyle Chaney relies on XPS to hold up to extreme race conditions.



Phil Blurton

**2017-2018-2019 UTV WORLD CHAMPIONSHIP WINNER
2017-2018 BITD UTV PRO PRODUCTION TURBO CHAMPION**

XPS lubricants are what get a naturally-gifted driver like Phil Blurton to the top of the podium.



Hunter Miller
2018 GNCC XC1 PRO TURBO UTV CHAMPION
 Multiple-time short course champion
 Hunter Miller has won with XPS in all conditions.



WHY XPS OIL IS THE PERFECT FIT FOR YOUR ROTAX ENGINE?

Just like you count on Can-Am to help you make the most of every terrain, you can trust XPS to ensure the long-lasting performance and durability of your Rotax engine.

ULTIMATE PERFORMANCE

Engineered to match the advanced performance of Rotax engines.

UNMATCHED RELIABILITY

Get the most out of every mile on every ride.

MADE FOR THIS

Developed with Rotax engines to deliver the best performance and lubrication in all conditions.



XPS oil undergoes rigorous worst-case scenario testing, and as a result is the trusted lubricant of many Can-Am racers.

can-amoffroad.com

ALL SET FOR YOUR RIDE?

4T 10W-50 SYNTHETIC OIL

- Engineered for heavy-duty and high-performance 4-stroke engines, including turbocharged, supercharged and racing engines.
- Formulated using carefully selected and strenuously tested base stocks and custom additives.
- Offers thick film strength to protect bearings, and a proven high-temp detergency to minimize deposits, prevent shear, provide thermal stability, and combat fuel dilution to ensure maximum performance from your engine.

779234 • 1 quart / 946 ml

779235 • 1 US gallon / 3.785 L

4T 0W-40 SYNTHETIC OIL

- 4-stroke engines powering recreational vehicles through mud, snow and water withstand a lot of high RPM and high load abuse, and this full synthetic oil is carefully engineered to provide the best protection for high-performance ATVs and SSVs.
- Its wide operating temperature range, additional corrosion protection, and engineered detergency make this oil the best choice for any powersport vehicle with a 4-stroke engine used in cold weather.

779139 • 1 quart / 946 ml

779140 • 1 US gallon / 3.785 L

4T 5W-40 SYNTHETIC BLEND OIL

- This synthetic blend is the oil of choice for owners of high-performance vehicles with a 4-stroke engine, including turbo or supercharged engines requiring carefully engineered friction.
- Combining the finest quality synthetic base stocks with extreme-tested synthetic additives, it provides superior engine and transmission protection against rust and corrosion compared to conventional engine oils.

779133 • 1 quart / 946 ml

779134 • 1 US gallon / 3.785 L



Note: Please contact your dealer for suggested retail prices of XPS products.

Some products shown may not be available or homologated in your country. Contact your BRP dealer for local details.

GET THE OIL CHANGE KIT THAT KEEPS YOUR ROTAX ROARING

Protecting your investment by changing your engine oil at regular intervals should be at the top of your maintenance to-do list. To make the task easier, we developed the XPS Engine Oil Change Kit for an all-in-one solution that saves time and money.

can-amoffroad.com



ENGINE OIL CHANGE KIT

- Ultra-convenient "all-in-one" Engine Oil Change Kit saves time and money.
- Includes XPS Synthetic or Synthetic Blend Oil, oil filter, o-rings and washer.

779256 • Synthetic Blend
(5W-40 450 cc or less (except Rally and DS ATVs))

779257 • Full Synthetic
(0W-40 450 cc or less (except Rally and DS ATVs))

779258 • Synthetic Blend (5W-40 500 cc or more V-twin engine)

779259 • Full Synthetic (0W-40 500 cc or more V-twin engine)

779252 • Full Synthetic (10W-50 500 cc or more V-twin engine)

779260 • Synthetic Blend (5W-40 900 ACE)

779261 • Full Synthetic (10W-50 900 ACE)



EXPERT CHOICE

Love to DIY?
Save money, time,
and effort: everything
you need for an oil
change is in this box.

SYNTHETIC GEAR OIL

- Uses custom additives to provide the best performance in Visco-Lok & Smart-Lok differentials.
- Allows higher loads, superior shear stability and reduced oxidation.
- Exceptional wear protection and superior performance at all operating temperatures.

75W-90

779158 • 1 quart / 946 ml

75W-140

779160 • 1 quart / 946 ml



SYNTHETIC GREASE SUSPENSION

- Designed to work specifically with the components found in Can-Am vehicle suspensions.
- It is highly stable and offers optimal lubrication at both extreme cold and high temperatures while protecting suspension components from dirt and moisture, as well as corrosion under extreme washout conditions.

779163 • 14 oz. / 400 g



ANTI-CORROSIVE LUBRICANT

- Multipurpose lubricant that can also be used to prevent rust, corrosion and moisture intrusion.
- It contains extreme pressure additives that work as an all-around lubricant for just about anywhere lubrication is needed.

293600016 • 12 oz. / 340 g



EXTENDED LIFE PRE-MIXED COOLANT

- XPS Antifreeze/Coolant contains the correct dilution and the necessary additives to prevent corrosion and inhibit cavitation in BRP cooling systems.
- Long-life, 5-year formula specially formulated for BRP vehicles.
- Superior heat transfer.
- Ideal replacement for vehicles that normally use a 2-year antifreeze/coolant (green).

779150 • 1 quart / 946 ml



Note: Please contact your dealer for suggested retail prices of XPS products.

DOT4 BRAKE FLUID

- Meets or exceeds all DOT3 and DOT4 brake fluid requirements.
- High-temperature formula resists fade, and also conditions seals and o-rings in braking system.

779151 • 12 oz. / 355 ml

**RACING BRAKE FLUID**

- Exceeds DOT4 brake fluid requirements for extreme conditions and competition use.
- Extreme, 579-degree boiling point temperature is ideal for high-demand competition conditions to combat brake fade.
- Will not harm seals or braking system components.
- Should be added only to a clean/unfilled system to avoid dilution and diminished performance.
- Low-moisture formula slows water vapor absorption through multiple heat cycles.
- Recommended for use in Ski-Doo and Can-Am racing applications.

779152 • 12 oz. / 355 ml

**HIGH PERFORMANCE SUSPENSION FLUID**

- A synthetic, fade-free formula for servicing FOX[®] shocks.
- Specially formulated for high-demand or racing application.
- Ultra high VI shock oil.
- Engineered viscosity for optimized performance with FOX[®] shocks valving.

779153 • 1 quart / 946 ml

**FUEL STABILIZER**

- Ethanol-compatible and will stabilize fuel in your tank to keep it from breaking down and causing hard starting, throttle hesitation and poor run quality.
- Ethanol attracts moisture, and this product contains powerful anti-corrosion additives to protect fuel system components.
- Prevents problems associated with E10 fuels.

779171 • 8 oz. / 236 ml

**CARBON FREE FUEL TREATMENT**

- Combination of a fuel treatment and a fuel system cleaner that can be used periodically to restore lost starting or throttle performance, as well as maintain fuel system integrity and keep internal engine parts clean.
- It treats fuel for storage and addresses the moisture problems inherent in today's Ethanol-blended fuels, keeping ferrous and soft metal parts clean and free of corrosion.
- Uses patented, state-of-the-art additives.
- Cleans valves, sticky rings and combustion chamber.

779169 • 12 oz. / 355 ml

**FUEL TREATMENT CARBURETOR CLEANER**

- Complete fuel treatment specially formulated to prevent small engine problems caused by Ethanol-blended fuels.
- It removes fuel system gum and varnish that may have accumulated during storage, stabilizes fuel against breakdown for 12 months or more, and adds corrosion protection from moisture for short- and long-term storage.
- It also helps restore throttle response and easy starting.
- It can be used periodically to maintain fuel system integrity, keep carburetor jets clean, and also combat moisture problems caused by Ethanol-blended fuels to keep ferrous and soft metal parts clean and free of corrosion.

779172 • 12 oz. / 355 ml

**SPRAY CLEANER & POLISH**

- Removes dirt, grease, road grime and water marks easily and quickly.
- Non petroleum based formula will not harm plastic finishes.
- Protects against UV and ozone damage and resists dirt accumulation.
- It can be used on painted surfaces, fiberglass, chrome and plastics.

219702844 • 12 oz. / 340 g

**OFF-ROAD VEHICLE WASH**

- A biodegradable non-toxic cleaner that removes mud and dried-on dirt from your off-road vehicle.
- Whether grimy from the track, the woods or the fields, this cleaner will leave your off-road vehicle sparkling.
- When used as directed, XPS Wash is safe for all off-road vehicle finishes.

219701702 • 32 oz. / 946 ml

**MICROFIBER TOWELS**

- The latest in high-quality detailing towels.
- Made up of extremely fine fibers, their soft surfaces have been perfected for drying and polishing painted, gel coated and hard shiny surfaces.
- They are so absorbent they hold up to seven times their weight in water.
- Machine washable means they can be used over and over again.
- Pack of 2.

219701759



Note: Please contact your dealer for suggested retail prices of XPS products.

Some products shown may not be available or homologated in your country. Contact your BRP dealer for local details.

EXPLORE AN ENTIRE WORLD OF ADVENTURE WITH ALL OF OUR BRP PRODUCTS. BRP.COM



ski-doo LYNX SEA-DOO EVINRUDE ROTAX CAN-AM



WE'RE
BUILT
FOR
THIS



830201165

©2019 Bombardier Recreational Products Inc. (BRP). All rights reserved. ®, TM and the BRP logo are trademarks of BRP or its affiliates.

A BRP BRAND

